



USER MANUAL

Power System Control Panel/ Remote Combi Control

WPC-PSCP and *WPC-RCC* for the WPC-series



Art.nr. 40200861

WHISPER POWER BV
Kelvinlaan 82
9207 JB Drachten
Netherlands
Tel.: +31-512-571550
Fax.: +31-512-571599
www.whisperpower.eu

September 2014

**Reference**

This document applies to versions of firmware V1.3.34 or higher of the remote control. If any doubt about your software version, you can check it with the menu « Information on the system » page 71

Copyright © WHISPERPOWER BV. All rights reserved

TABLE OF CONTENTS

Foreword	8
Conventions	8
Product recycling	8
EC Declaration of conformity	9
Whisper Power BV contact details	10
Your reseller' contact details	10
Warnings and caution	11
Warranty	11
Limitation of responsibility	11
Safety instructions	11
Acceptance of the software licence and updates	11
Compatibility	12
Access code for extended functions	12
Introduction	13
Models concerned	13
Controls and indicators	13
SD card	14
Connection	15
Series connection	15
WPC-PSCP	15
Dimensions	16
WPC-PSCP	16
Quick Start Guide	17
Setting of the language	17
Adaptation to the source	17
Adaptation to the battery	18
Activation of the function Smart-Boost	19
Basic displays	20
Activating and deactivating the WPC	21
Quick setting of the maximum source AC current	21
Setting of the RCC/PSCP remote control	22
Setting of the language {5000}	22
Other languages {5036}	22
Setting of time {5001} and date {5002}	23
User level {5012}	23
Drive the remote control to the user level basic {5019}	23
INSTALLER - Modification of the WPC parameters thresholds together {5042}	23
Force all WPC parameters to threshold {5043}	23
Restore the default thresholds of the WPC parameters {5044}	23
Data logger {5057}	24
Data logger activated {5058}	24
Backup of the current day data {5059}	24
Backup and restoring {5013}	24



Backup of all files {5041}	24
Loading of all files {5068}	24
Separator of the csv files {5032}	24
Advanced backup functions {5069}	25
Messages backup {5030}	25
Backup and restore of remote control files {5049}	25
Backup of remote control configuration {5015}	25
Loading the remote control configuration {5016}	25
Save and restore WPC files {5050}	25
Backup of WPC configuration {5017}	25
Loading the WPC configuration {5018}	25
INSTALLER - Create a master file {5033}	25
Loading a master file {5034}	26
Load WPC parameters preset {5045}	26
Adjustment of the contrast {5006}	26
Adjustment of the back-lighting {5007}	26
Back-lighting always off {5008}	26
Duration of the back-lighting {5009}	26
Red back-lighting if the WPC is OFF and if there is a fault {5026}	26
Inactivity period before returning to the standard display {5010}	26
Duration of display for quick messages {5011}	26
Acoustic alarm {5027}	26
Remote control acoustic alarm duration {5031}	26
Switching on and off of system on level View only {5056}	27
Choice of the display by default {5073}	27
Information on operating the installation.....	28
Display of the parallel and three-phase systems.....	29
Messages and account of events	30
(000) Alarm: Low battery voltage.....	30
(003) Message: AC IN synchronization in progress.....	30
(004) Message: Wrong AC-In input frequency	31
(006) Message: Too high AC-In input voltage	31
(007) Message: Too low AC-In input voltage	31
(008) Stop: Overload inverter SC	31
(014) Stop : Over temperature EL	31
(015) Stop: Overload inverter BL.....	32
(016) Alarm: Ventilation fault detected	32
(018) Alarm: Excessive battery ondulation	32
(019) Stop: Too low battery voltage	32
(020) Stop: high battery voltage	32
(021) Message: Maximum Current of the source (Input limit) exceeded; transfer prohibited	32
(022) Error: Voltage at AC Out	32
(023) Error: Phase not defined	33
(024) Message: Control the battery of the clock	33
(041) Alarm: Over temperature TR.....	33
(042) Stop: Source at the output	33
(058) Error: Lost of synchro master.....	33
(059) Stop: Overload inverter HW	33
(060) (061) Alarm: Maximum duration security for auxiliary contact.....	33
Stored events	34
Data logging	35
Functioning.....	35
SettingS of the WPC	36
General	36



Configuration on a system with several WPC's.....	36
Utilisation and access levels	36
Access to the parameters	36
Access to a parameter by its number	37
Access to a parameter via the menu	37
INSTALLER - Utilisation and access levels	37
BASIC CONFIGURATIONS {1100}.....	38
Maximum current of the AC source (Input limit) {1107}	38
Charge current {1138}	39
Smart boost authorized {1126}	39
Authorized inverter {1124}.....	39
Type of detection of AC input loss (UPS) {1552}	39
Standby level {1187}.....	39
Restore default configurations {1395}	40
INSTALLER - Restore factory settings {1287}.....	40
MANAGEMENT AND BATTERY CYCLE {1137}	41
Authorized charger {1125}	44
Charge current {1138}	44
Temperature correction coefficient {1139}	44
Under voltage {1568}.....	44
Level of battery under voltage at no load {1108}	44
Dynamic compensation of the batteries under voltage {1531}	45
Duration of under voltage before disconnection {1190}	45
Reactivation voltage after battery under voltage {1110}.....	45
Acoustic alarm of the battery under voltage {1196}	45
Adaptable low voltage disconnection {1194}	45
Adaptable battery low voltage disconnection maximum voltage {1195}	45
Reset voltage of the adaptable correction {1307}	45
Increment of the adaptive correction {1298}.....	46
Maximum operating voltage {1121}.....	46
Reactivation voltage after battery overvoltage {1122}	46
Battery maintenance voltage (floating) {1140}.....	46
Force passage to floating mode {1467}	46
New cycle {1141}	46
Force new cycle {1142}.....	46
Voltage 1 for a new cycle {1143} and duration at under voltage 1 for a new cycle {1144}	46
Voltage 2 for a new cycle {1145} and duration at under voltage 2 for a new cycle {1146}	46
New priority cycle on the absorption and equalization phases {1149}	47
Restricted maximum cycle frequency {1147}	47
Absorption phase {1451}	47
Authorized absorption {1155}	47
Absorption voltage {1156}.....	47
Duration of absorption {1157}.....	47
Completion of absorption released by the current {1158}	48
Control of the maximum frequency of the absorptions {1160}	48
Equalization phase {1452}	48
Authorized equalization {1163}.....	48
Force an equalization {1162}.....	48
Equalization before absorption phase {1291}	49
Equalization current {1290}	49
Equalization voltage {1164}	49
Duration of equalization {1165}	49
Number of cycles prior to equalization {1166}.....	49
Equalization at set intervals {1284}	49
End of equalization activated by the current {1168}	50
Reduced floating phase {1453}.....	50



- Authorized reduced floating phase {1170} 50
- Duration of floating before reduced floating {1171} 50
- Voltage of reduced floating {1172} 50
- Periodic absorption phase {1454} 51
 - Authorized periodic absorption {1173} 51
 - Periodic absorption voltage {1174} 51
 - Duration of reduced floating before periodic absorption {1175} 51
 - Duration of periodic absorption {1176} 51
- INVERTER {1186} 51
 - Authorized inverter {1124} 51
 - Output voltage {1286} 52
 - Increase of the linear AC-Out voltage with the battery voltage {1548} 52
 - Maximum increase of the AC-Out voltage by the battery voltage {1560} 52
 - Frequency {1112} 52
 - Increase of the frequency at full battery {1536} 53
 - Frequency increase with the battery voltage {1549} 53
 - Maximum increase of the frequency {1546} 53
 - Standby and start (load detection) {1420} 54
 - Standby level {1187} 54
 - Duration between the standby pulses {1189} 54
 - Number of standby periods {1188} 54
 - Duration of Soft start {1599} 54
 - Solsafe presence {1438} 54
- AC-IN AND TRANSFER {1197} 55
 - Transfer relay allowed {1128} 55
 - Delay before closing of the transfer relay {1580} 55
 - Maximum current of the AC source (Input limit) {1107} 55
 - Smart-Boost authorized {1126} 56
 - Overrun AC source current limit without opening the transfer relay (Input limit) {1436} 56
 - Activate immediate detection of grid outage (UPS) {1435} 56
 - Type of detection of AC input loss (UPS) {1552} 56
 - Tolerance on the immediate detection of a grid loss (tolerant UPS mode) {1510} 56
 - Transfer AC-In for delayed transfer opening {1199} 56
 - Delay before passing to inverter {1198} 56
 - Immediate transfer AC-In voltage {1200} 57
- INSTALLER – Absolute maximum input voltage {1432} 57
 - Max input current modification {1471} 57
 - Use an alternate max input current {1566} 57
 - Second maximum current of AC source {1567} 57
 - Decrease max input limit current with AC-in voltage {1527} 57
 - Decrease max input limit activated by remote entry {1554} 57
 - AC input low limit voltage to allow charger function {1309} 57
 - Adaptation range of the input current according to the input voltage {1433} 57
 - Speed of input limit increase {1553} 58
 - Charge current decrease coefficient at voltage limit to turn back in inverter mode {1295} 58
 - Frequency delta accepted above End {1505} 58
 - Frequency delta accepted below End {1506} 58
 - Duration of erroneous frequency before disconnecting the transfer relay {1507} 58
 - AC-In current active filtering {1575} 58
- CONFIGURATION FOR AUTOSTART AND GRID/GEN AC OUTPUT; AUXILIARY CONTACTS 1 AND 2 {1201} AND {1310} 59
- Simple functions 60
 - Switching mode {1202} {1311} 60
 - Temporal restrictions {1203} {1312} 60
 - Contacts activated with set schedules {1269} {1378} 60
 - Contacts activated by an event {1455} {1456} 61



WPC OFF {1225} {1333}	61
WPC ON {1518} {1519}	61
Remote ON/OFF input active {1543} {1544}	61
Battery under voltage alarm {1226} {1334}	61
Battery overvoltage {1227} {1335}	61
Inverter or smart boost overload {1228} {1336}	61
Over temperature {1229} {1337}	61
No over temperature alarm {1520} {1521}.....	61
Active charger {1231} {1339}.....	61
Active inverter {1232} {1340}.....	62
Smart-Boost active {1233} {1341}.....	62
AC In present with fault {1234} {1342}.....	62
AC In present {1235} {1343}.....	62
Transfer relay drawn {1236} {1344}	62
AC Out present {1237} {1345}.....	62
Battery charging in bulk charge phase {1238} {1346}	62
Battery charging in absorption phase {1239} {1347}	62
Battery charging in equalization phase {1240} {1348}.....	62
Battery charging in floating phase {1242} {1350}.....	62
Battery charging in reduced floating phase {1243} {1351} and.....	62
Battery charging in periodic absorption phase {1244} {1352}	62
Autonomy test in progress {1529} {1530}.....	62
Contacts activated by the battery voltage {1245} {1353}.....	63
Dynamic compensation of the thresholds {1288} {1354}	63
Deactivate if the battery is in floating mode {1516} {1517}	63
Contacts activated by inverter power or Smart-Boost.....	63
{1257} {1366}	63
Contacts activated according to the battery temperature {1503} {1504}	64
Contacts activated on battery state of charge (SOC) {1501} {1502} (function active only with a BSP)	64
Security : Limit the time of activation {1512} {1513}.....	64
Maximum duration of activation {1514} {1515}	64
SYSTEM {1101}.....	64
Command entry {1537}	64
Command entry active {1545}.....	65
Prohibits transfer relay {1538}	65
Inverter prohibited {1539}	65
Charger prohibited {1540}.....	65
Smart Boost prohibited {1541}	65
Forbids grid-feeding {1542}	65
Command ON/OFF {1576}	65
Activated by the state AUX1 {1578}.....	65
Forbids the battery as priority source {1579}	65
Reset all settings {1569} {1570}	65
Battery as priority energy source {1296}.....	66
Voltage of the battery priority {1297}	66
Duration of the acoustic alarm {1565}.....	66
Automatic restart {1129}.....	66
Auto-start when switched on {1111}.....	67
Ground/neutral system {1484}	67
Ground relay prohibited {1485}	67
Neutral always connected {1486}.....	68
Self-test of autonomy {1473}.....	68
Weekly test {1474}	68
Monthly test {1478}	68
Manual start of a monthly test {1496}	68
Month of test {1479}	68





Date of the monthly test {1480}	69
Day of the week of the monthly test {1481}	69
Time of test start {1482}, Duration of test {1483}	69
INSTALLER – Flash saving of the parameter {1550}	69
Reset of all inverters {1468}	69
MULTI WPC {1282}	69
3-phase integral mode {1283}	69
Multiple authorized inverters {1461}	69
Multiple independent inverters {1462}	70
Authorize the stand-by of the secondary inverters (slaves) {1547}	70
Splitp hase (dual phase) : L2 with 180 degrees phase displacement {1571}	70
GRID-FEEDING {1522} (Is out of the scoop of this manual)	70
Information on the system	71
Remote controls	71
WPC	71
SOFTWARE(S) UPDATING	72
UPDATING PROCESS	72
Appendices	73
Appendix 1 : List of configuration interdependencies	73
Parameters table	74
Remote control parameters	74
WPC parameters	76
Index of the numbers of parameters {xxxx}	89
Notes	91

FOREWORD

This manual contains information relating to the functioning of the WPC-RCC and WPC-PSCP remote controls.

The use of certain functions sometimes requires increased knowledge in various fields. This manual cannot provide this. In case of doubt, please contact your reseller or installer.

CONVENTIONS

	This symbol is used to indicate the presence of a dangerous voltage that is sufficient to constitute a risk of electric shock.
	This symbol is used to indicate a risk of material damage.
	This symbol is used to indicate information that is important or which serves to optimize your system.

Terminology

The following terms are used in the manual to provide greater clarity:

RCC/PSCP is used to indicate the remote control WPC-RCC or WPC-PSCP if the description applies to both models.

Installation is used to describe all the electrical equipment connected together. This may be the source (public grid or generator), and one or more WPC(s) with or without remote control as well as electrical consumers.

System is used to describe the entirety of WPC's with or without remote control.

WPC or **Whisper Power Centre** is used to describe one combi unit.

PRODUCT RECYCLING

The RCC/PSCP remote control conforms to the European directive 2002/95/EC on hazardous substances and does not contain the following elements: lead, cadmium, mercury, hexavalent chrome, PBB or PBDE.



To dispose of this product, please use the service for the collection of electrical waste and observe all applicable obligations according to the place of purchase.



EC DECLARATION OF CONFORMITY

EC DECLARATION OF CONFORMITY

In accordance with EN ISO 17050-1:2004

The remote control described in this manual complies with the following standards:
EN 61000-6-1, EN 61000-6-3, EN 55014, EN 55022, EN 61000-3-2

Signed by:

Name: Dr. R.E.Bosman,

Technical Director,
Drachten
Date: June 2011



WHISPER POWER BV CONTACT DETAILS

Whisper Power BV
Kelvinlaan 82
9207 JB Drachten

Tel. + 31 (0)512 57 15 50
Fax. + 31 (0)512 57 15 99

Email: info@whisperpower.nl

Website: www.whisperpower.eu

YOUR RESELLER' CONTACT DETAILS



WARNINGS AND CAUTION

WARRANTY

WhisperPower warrants its full range of inverters to be free from defects in workmanship and materials for a period of 5 years from the date of manufacture.

Any warranty claim will be refused if it is not sent back to the point of sale, or another place indicated by WhisperPower, in appropriate packaging and accompanied by a copy of the dated proof of purchase.

No warranty claims will be accepted for damage resulting from handling, usage or processing that does not explicitly appear in this manual.

Cases of damage arising from the following causes are notably excluded from the warranty:

Inappropriate use

The presence of liquids in the device or oxidation resulting from condensation

Damage resulting from falls or mechanical shocks

The opening or alteration of the RCC/PSCP remote control, carried out without the explicit authorization of WhisperPower

Damage due to atmospheric surge voltage (lightning)

Damage from transportation due to inappropriate packaging

LIMITATION OF RESPONSIBILITY

The placement, commissioning, use, maintenance and servicing of the RCC/PSCP remote control cannot be the subject of monitoring by WhisperPower. For this reasons WhisperPower assumes no responsibility and liability for damage, costs or losses resulting from an installation that does not conform to the instructions, from a defective functioning or from a deficient maintenance.

The use of WhisperPower devices is the responsibility of the customer in all cases. This equipment is neither designed nor guaranteed to supply installations used for vital medical care nor any other critical installation carrying significant potential damage risks to people or the environment.

WhisperPower does not assume any responsibility for the infringement of patent rights or other rights of third parties that result from using the devices.

The responsibility of WhisperPower may not under any circumstances exceed the amount spent to purchase the product.

WhisperPower reserves the right to make any modifications to the product without prior notification.

SAFETY INSTRUCTIONS

Carefully read the following safety instructions in order to avoid any injury or risk of damaging this product and those that are connected to it.

Only use the connection cable specified and supplied by WhisperPower. Under no circumstances should you use a damaged cable. In case of doubt about the condition of this device, it should be inspected by a qualified technician.

Do not use the RCC/PSCP remote control in a humid environment.

Do not use the RCC/PSCP remote control in an explosive environment.

Also read the safety instruction in the manual of the WPC

ACCEPTANCE OF THE SOFTWARE LICENCE AND UPDATES

The remote control unit RCC/PSCP works with software that will remain in ownership of Whisper Power.

By using the RCC/PSCP remote control, you are accepting the terms and conditions of the following licence agreement. Please read this carefully.

WhisperPower is granting a limited licence to use the software installed in this equipment in its executable binary format during the normal functioning of the product. The title, the property rights and the copyrights relating to this software, remain the property of WhisperPower.

You acknowledge that the software is the property of WhisperPower and that it is protected by copyright law according to the international copyright treaties.



You also acknowledge that the structure, organisation and software code are valuable commercial secrets belonging to WhisperPower. You agree not to decompile, disassemble, alter or reverse either the unit or the engineering or make the software readable, irrespective of which part of the software, or to create any work whatever that is based on this software.

Updating must be done in the full awareness of the cause and is always the responsibility of the customer. Partial updates may cause ruptures in the compatibility or in its stochastic operation.

COMPATIBILITY

WhisperPower guarantees the compatibility of the software updates with the hardware for one year, starting from the date of purchase. The updates are no longer guaranteed beyond this date and a hardware upgrade may be required. Please contact your reseller for any additional information on compatibility.

ACCESS CODE FOR EXTENDED FUNCTIONS

In order to use the WPC-RCC, WPC-PSCP remote control in extended mode, you must have installer or INSTALLER level authorisation from WhisperPower. After your accreditation you will receive a code number which will allow you to access these functions. This code number is exclusively valid for devices manufactured during the current year or older, the most recent code may therefore be used for all operations.

Fill in the code you have received below in order to take advantage of the extended functions of the WPC-RCC, WPC-PSCP remote control.

Year	Code
2011-2015	

The additional functions available with a professional user level appear in gray in this manual. Depending on your access code, you may not have access to all the functions described in this manual. Certain functions are reserved for servicing or factory testing. Please ask your supplier for more details on this subject.

INTRODUCTION

Congratulations! The purchase of an RCC/PSCP remote control offers you unlimited access to the various functions of the devices in the WPC series. Numerous configurations that can now be accessed allow you to optimize the operation of the installation. Despite all these options, the WPC works on a simple basis.

Different figure scenarios as well as associated configurations are presented at the end of this manual.

The manual for the RCC/PSCP remote control is divided into several distinct parts:

The first part (page 15 to 27) is dedicated to the adjustments of the RCC/PSCP remote control, whether this is the language used or the clock, which are sometimes necessary for the whole installation to work well.

The second part (page 28 to 34) is concerned with immediate information on the installation. This gives access to the electric values such as the battery voltage, inverter load and many more.

The third part (page 35) shows the functions for saving events occurring in the installation. This may be necessary for diagnosing a weakness or simply to check that the whole unit is working well during its whole service life.

The fourth part (page 36 to **Error! Bookmark not defined.**), which is more technical, presents various options for configuring the WPC.

Do not change the configurations except when you have the technical knowledge; otherwise, the operation of the installation could at risk or installation itself could be partly damaged.

The fifth part (page 71 to 74) consists of more general items like information about the system, the updating process.

The sixth part (page 74 to 88) consists of two tables with all "Remote control" and "Inverter" parameters. These tables, which hierarchy follows exactly the order as in the remote control, give an overview on all adjustable parameters and also the information about factory settings.

MODELS CONCERNED

The RCC/PSCP remote control may be connected to any WPC, the use of which is clearly detailed in its operating instructions.

CONTROLS AND INDICATORS

The RCC/PSCP remote control is equipped with four operating keys as well as a graphic display with back-lighting. The function of the keys may change according to the context of utilisation and a reminder of the function in progress is given at the right of the display.

Generally the keys UP and DOWN are used to alter values or options relating to what is on the display and the two central keys are used to access, confirm or quit the item shown.

If the back-lighting function is activated, pressing one of the keys starts it up.



SD CARD

The RCC/PSCP remote control is equipped with an SD (Secure Digital)-type memory card reader. This card (supplied) is used for various functions described in this manual. It allows, amongst others, the following functions: recording statistics, updates, backups or restoration of configurations or adjustments. The filing system used for the data is the FAT system (FAT16). This card can be read using any standard SD card reader.

As far as the WPC-PSCP is concerned, the use of the SD card requires removing the remote control since the access to the SD lies behind.



WPC-PSCP

	<p>The system of the card reading is compatible with the following types of cards:</p> <ul style="list-style-type: none">• SD• SD HC <p>The system of the card reading is incompatible with the following types of cards:</p> <ul style="list-style-type: none">• SD XC• Cards of more than 32 GB
--	---

CONNECTION

The remote control WPC-RCC/PSCP is meant to be integrated. It must be mounted by means of 4 screws (not supplied) on a flat place without any mechanical constraints to the front plate. Once the RCC/PSCP remote control is fastened it can be connected to the inverter using the authorized cable only. If the cable is damaged or if a socket is detached, the cable must not be connected since this can lead the whole installation to malfunction.

A maximum of 3 remote controls can be connected to one unit.

SERIES CONNECTION

To connect several RCC/PSCP remote controls in series, you must activate termination at the two extremities on both units and deactivate it on the intermediate units.

Termination is activated on each WhisperPower product by default.

Activate the termination on each element of the series connected with a single cable.

Deactivate the termination on each element of the series connected with two cables.

To deactivate the termination on an inverter or RCC/PSCP remote control, turn the switch to the right.

WPC-PSCP

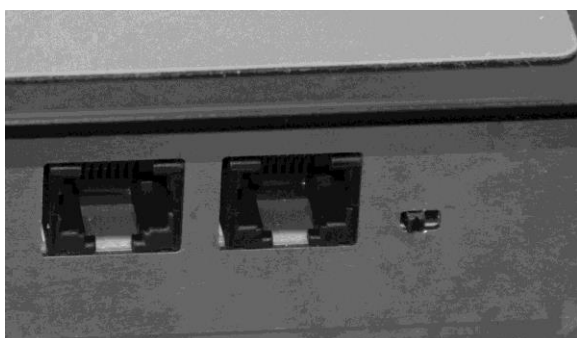

WPC-PSCP termination activated
(left position)

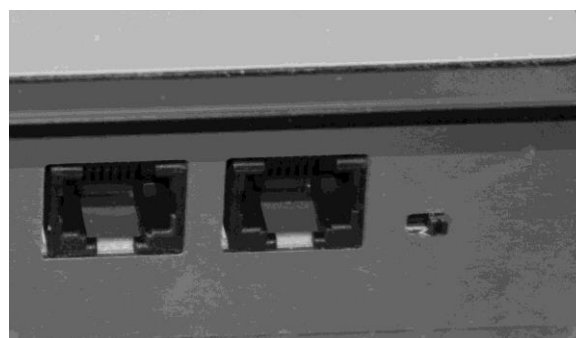

WPC-PSCP termination deactivated
(right position)

On a WPC to activate the termination, put the mini-switch on position T, to deactivate it, move it to the right on position O.



DIMENSIONS

WPC-PSCP

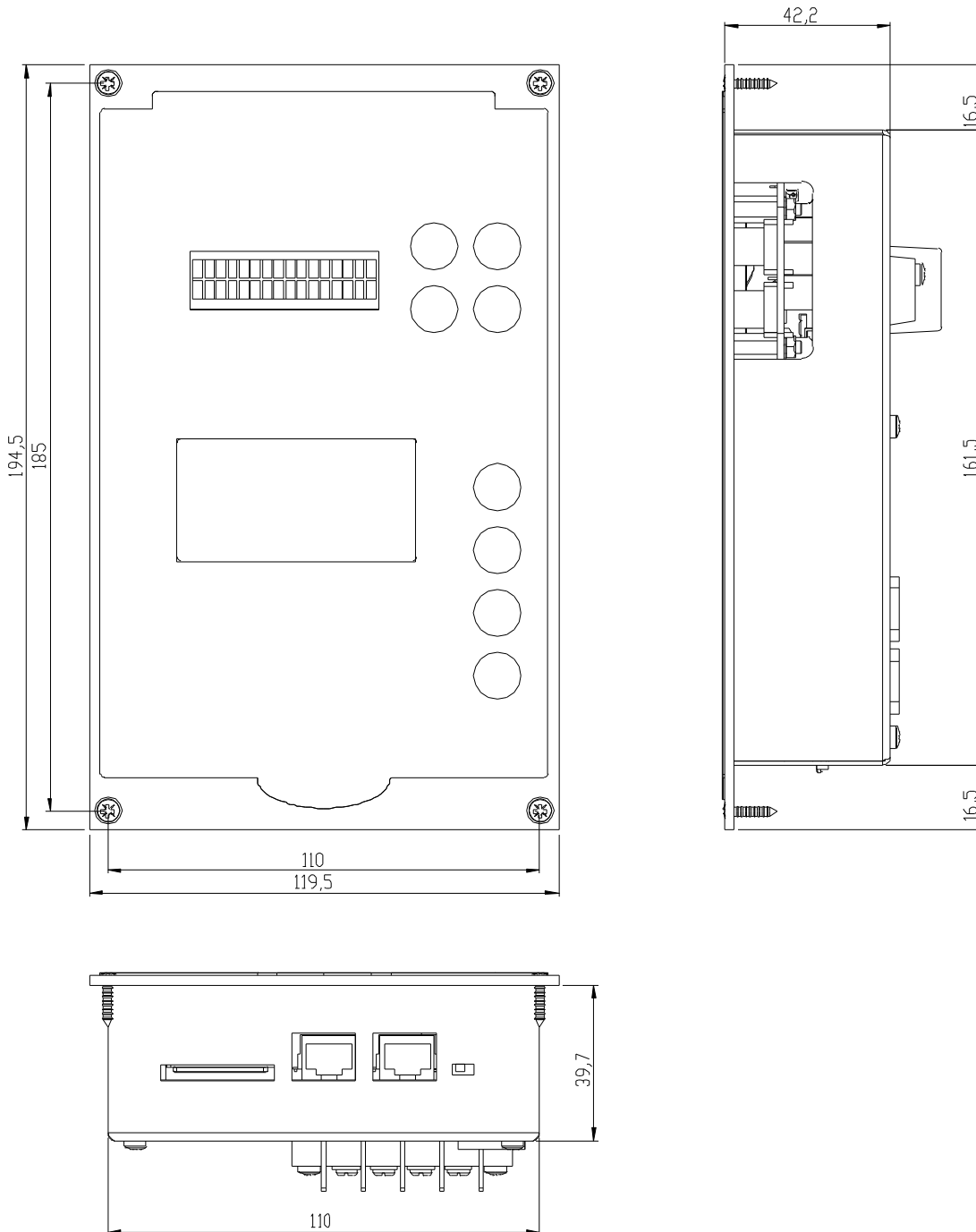

QUICK START GUIDE

The remote control RCC/PSCP gives you access to a many settings possibilities. However, in most cases the setting of two parameters only is required for the perfect running of your installation.

SETTING OF THE LANGUAGE

To begin, set your remote control RCC/PSCP for a display of the information in English.

The basic display is:

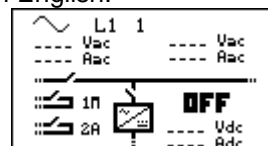

Press 1 time on the key "arrow downwards" to display the following screen:

Once beyond this screen you can come back to it by means of the key "arrow upwards".

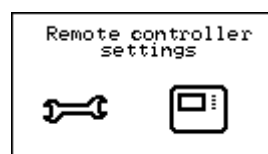

Press the key SET to enter the remote control settings. The screen of the language choice appears.

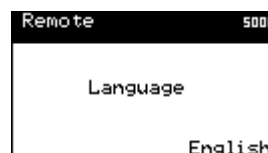

Press once more the key SET to modify the current language. The language then appears in reverse video.



With the keys "arrow upwards" and "arrow downwards" choose the language you wish. Then validate your choice by means of the key SET (OK).

We can now leave the setting of the remote control with the key ESC.

ADAPTATION TO THE SOURCE

It is a matter of indicating to the WPC the power available to charge the batteries and to supply the users. In order to adapt your installation to the source it is connected to, proceed as follows:

The basic display is:

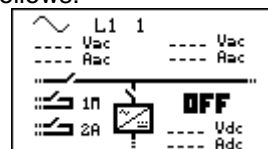

Press 2 times on the key "arrow downwards" to display the following screen:

Once beyond this screen you can come back to it by means of the key "arrow upwards".

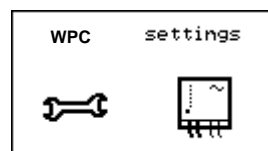

Press the key SET to access to the settings.

Then again on the key SET to access to the basic parameters.

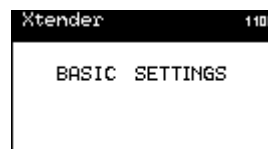

You can now adapt your installation to the source which it is connected to.
 Max. current of the AC source (Input limit) {1107}.



i When an asterisk (*) is present, it informs you that the selected value corresponds to the one set in factory by default (factory setting).

i In case of using the WPC on a public grid, it is actually the value of the circuit breaker on the source side (fuse or breaker).
 In a building, this value lies generally between 8 and 16A.
 In the case of a shorepower or of a camping terminal, it lies between 2 and 6A.
 In case of using the WPC on a genset, you can divide the genset power by the operating voltage (for instance for a genset of 3500VA, or 3500W, and 230V you get $3500/230=15.2$).

Press the key SET to modify the value of this parameter (it appears in reverse video). By means of the keys "arrow upwards" and "arrow downwards" change the value to adapt it to your source and validate your setting with the key SET (OK).

ADAPTATION TO THE BATTERY

Charge current {1138}

In order that your WPC manages the best possible the energy stored in your batteries and that it charges them optimally, it is necessary to indicate the current which they can be charged with. You will find this value in the technical data provided by your batteries manufacturer.

i In the case of lead-acid batteries, one generally uses one tenth or one fifth of the battery capacity value.
 For instance for a 500Ah battery: $500/10=50A$ to $500/5=100A$.

The basic display is:

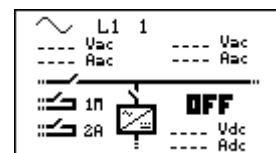

Press 2 times on the key "arrow downwards" to display the following screen:
 Once beyond this screen you can come back to it by means of the key "arrow upwards".

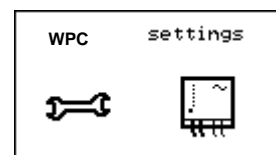

Press the key SET to access to the settings.
 Then again on the key SET to access to the basic parameters.
 With the key "arrow downwards", access the menu "Battery and charger cycle".

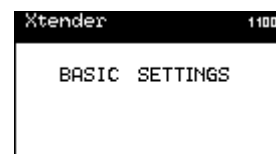

You are now going to set the charge current for the batteries:
 Press the key SET to modify the value of this parameter (it appears in reverse video). With the keys "arrow upwards" and "arrow downwards" change the value to adapt your battery and validate your setting with the key SET (OK).

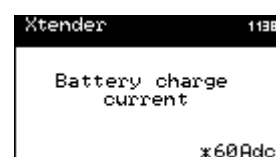

ACTIVATION OF THE FUNCTION SMART-BOOST

If your AC-In source is limited in power, the WPC can work as a support and add the missing power for your loads.

First of all, check that you have adapted the WPC to your source (see previous chapter: Adaptation to the source {1107})

The basic display is:

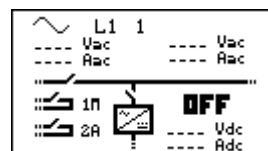

Press 2 times on the key "arrow downwards" to display the following screen:

Once beyond this screen you can come back to it by means of the key "arrow upwards".

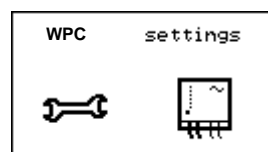

Press the key SET to access to the settings.

Then again on the key SET to access to the basic parameters.

Press 2 times on the key "arrow downwards".

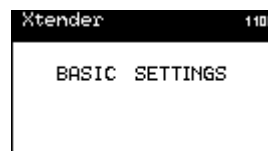

You reach now the parameter for authorization of the Smart-Boost function {1126}.

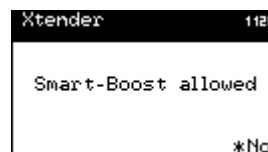

You can now authorize the function. Press the key SET to access this parameter in modification mode, then the keys UP or DOWN to change the option. To end up, validate with the key SET.

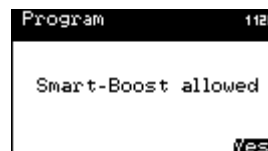

BASIC DISPLAYS

When the remote control is connected to an WPC, it is possible to access to different display menus divided into distinct categories.

Information on the system

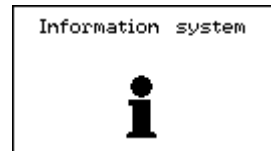

The history of events occurring in the installation



Real time information displays on the operating mode of the installation

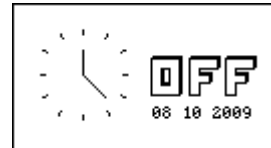

The different measures carried out by the BSP
(Only if a BSP is present)

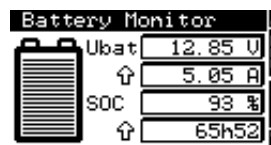
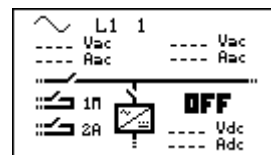

Adjustment of RCC/PSCP remote control options

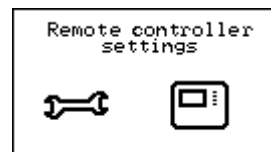

Adjustment of configurations on the WPC(s)

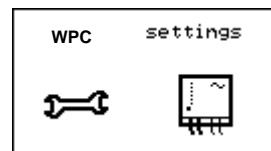

The settings of the BSP
(Only if a BSP is present)



Information

Setting

To go from one display to the other, use the keys UP and DOWN on the RCC/PSCP remote control.
To visualize or modify the options of one of the basic displays, press the key SET when this one is displayed.

i Depending on the components connected to your system, it is possible that other displays complete this series.

In the case of a system in 3-phase or in parallel, the following displays are available too:

Real time display of information on the state of running of the installation

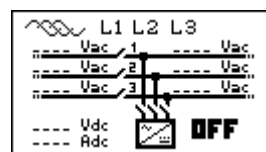
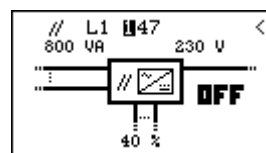

ACTIVATING AND DEACTIVATING THE WPC

When one of the displays is visible, it is possible to activate or deactivate the WPC. To do this, simply press the key ESC. The key request on the screen indicates whether you are going to activate or deactivate the unit.

Once the key has been pressed, you must confirm your choice by using the key YES. If you do not want the action to be carried out, it can be cancelled by pressing the NO key.

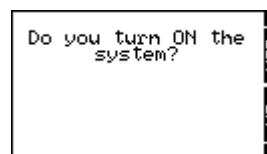

i Note: This is a comprehensive signal and leads to the stoppage or starting of all WPC's connected to the remote control.

i Putting ON or OFF the system can be easily done directly on the WPC with the button:



QUICK SETTING OF THE MAXIMUM SOURCE AC CURRENT

It is possible to access directly to the setting of the AC source maximum current (Input limit) {1107} with the key SET (FAST) from the simplified display (clock).

i For the users travelling, the available source often differs in power. This quick access menu allows to easily set the maximum current available.

Parameter	Naam	Fabrieksinstelling	
1107	Max. current AC in (Input limit)	16	A

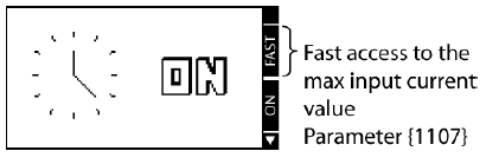

SETTING OF THE RCC/PSCP REMOTE CONTROL

This screen gives you access to the remote control basic settings. From one of the basic menu items, use the keys UP and DOWN until reaching the item "Adjustment of the remote control", then confirm by using the key SET.

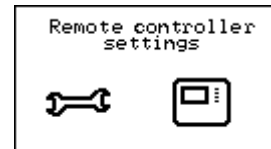

When the item to be modified appears on the screen, press the key SET to be able to modify it. This value then displays in inverse video. Now use the keys UP and DOWN to modify it. Once the correct value has been obtained, confirm by using the SET key or exit without modifying by using the key ESC.



 Each configuration has a unique ID displayed top right (see example below) these numbers are indicated between curly brackets in this manual : {xxxx}

EXAMPLE to modify the current date
Go to the following screen using the UP and DOWN keys.
Press the key SET to access the remote control adjustment.

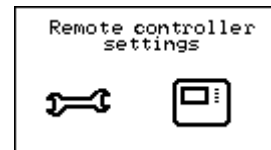

Go to the following screen using the key DOWN.
Press the key SET to modify the configuration



Set the correct date using the keys UP and DOWN
Go to the adjustment of the month using the key SET
Also set the month using the keys UP and DOWN
To complete, go to the year adjustment using the key SET
After having adjusted the year using the keys UP and DOWN,
confirm using the key SET.



SETTING OF THE LANGUAGE {5000}

The default language is English and the WPC can store up to four languages simultaneously. This configuration allows you to choose one of them.

OTHER LANGUAGES {5036}

The default available languages in the remote control are: English, French, German and Spanish. It is possible to change the languages memorized in the remote control. For this you must use a SD card with the latest update available on our website (www.whisperpower.eu). Ask your reseller to know what languages are available.

The first language available (English) can not be modified.

To change a language, follow this process:

- Make sure you have a SD card with the file for the language you wish to use



- Insert the SD card and wait for an possible automatically update of the remote control
- Enter the menu „other languages“ {5036}
- Choose the language you wish to replace (second, third or fourth {5038} {5039} {5040}) and select the new language
- The updating is done automatically

SETTING OF TIME {5001} AND DATE {5002}

The WPC has a perpetual calendar and an internal clock powered by a backup battery. The correct adjustment of the date and time allows accurate recording of events occurring in the installation as well as correct use of time-related functions, e.g. the disabling of the auxiliary relays during the night.

USER LEVEL {5012}

The setting of the user level allows you to choose the access to the WPC according to your level of expertise, or to prevent the use by users such as on a rent a boat.

The **INFO ONLY** level may be selected by entering the code:

460081

This level does not allow the WPC configurations to be modified, it only allows information to be displayed on the system.

	Use the INFO ONLY level after adjusting the configurations if the remote control is located in a public place or if it is accessible by people who are not authorized to carry out adjustments on your system. You may change the level at any time to make new adjustments, by entering the appropriate code.
--	---

The **BASIC** level allows you to configure basic WPC functions, limiting the field of actions to simple configurations. Please note that the incorrect adjustment of basic configurations may lead to the malfunctioning of the installation. This level is selected by default. To return to this level after a change, enter code:

943274

The **EXPERT** level allows access to more complex WPC configurations and this level of usage may only be used with extensive specialist knowledge. To access the expert level, enter code:

426468

DRIVE THE REMOTE CONTROL TO THE USER LEVEL BASIC {5019}

You can with this option bring the remote control back to the level “user Basic”.

	Use this function at the end of the system setting to go out of the EXPERT mode.
--	--

INSTALLER - MODIFICATION OF THE WPC PARAMETERS THRESHOLDS TOGETHER {5042}

Force all WPC parameters to threshold {5043}

Restore the default thresholds of the WPC parameters {5044}

DATA LOGGER {5057}

Data logger activated {5058}

Activated the data logger.

Every day at midnight a CSV file is created on the SD card in the directory CSVFILES, in the subfile LOG. This file contains the recordings minute after minute of the main system electrical values.

This file can reach the size of 1MB. Make sure that the space available on the card is enough.



The remote control writing system is not guaranteed for all kinds of SD cards. It does not work with cards formatted with the FAT32 system. The cards with a size over 2GB are not compatible.



In case of software updating of the system, the data of the day are lost.



You will find more information and the easiest method to exploit these data in the chapter „Data logger“, p.35 of this document.

Backup of the current day data {5059}

If you want to have the data of the current day, you can force the recording of the data of the day with this function. The file then created will only be partial and a new file with all data will be generated at midnight.

BACKUP AND RESTORING {5013}

The different options of this menu allow you to do a safety backup of your system or various actions in relation to the SD card.



The remote control RCC/PSCP is not compatible with all types of SD cards. Cards with FAT32 formatting system are not supported, therefore cards with more than 2GB can not be used.

Backup of all files {5041}

This function enables to save in one operation all files linked to the remote control:

The files of events history

The files of the remote control parameters

The files of the WPC parameters



Caution : while using this function with a 9 WPC system, the process of copying files can last up to 15 minutes.

Loading of all files {5068}

This parameter restores all WPC's, BSPs and remote controls settings saved with the parameter "Backup of all files {5041}".

Separator of the csv files {5032}

With this option you can choose the field separator for the csv file. The separator must be adapted to the operating system and the language used in order to be correctly interpreted. You can choose in between the "automatic" mode (which will select automatically the separator according to the language set on the WPC-



RCC/PSCP), a coma (,) or a semicolon (;). In case of systems in French/German/Italian, this is the semicolon (;) that is normally used, while for systems in English/Chinese, this is the coma (,).

Advanced backup functions {5069}

Messages backup {5030}

This parameter allows to save the message files (Event history) on the SD card. The data are written in a CSV format file that can be read by almost all spreadsheets and word processing softwares. The file is written in a directory called STATS and in a subdirectory which shows the backup date.

Backup and restore of remote control files {5049}

Backup of remote control configuration {5015}

This function writes useful configurations for the operation of the remote control on to the SD card. You can use this function to do a backup of the remote control parameters or to visualize on a computer the values that you have selected.

The file in CSV format is written in a directory called CSVFILES\« FID »\DATE.

The directory FID indicates the unique identification of your remote control and contains the subdirectory which indicates the date of backup.

Loading the remote control configuration {5016}

Reload the remote control configurations. If several files have been created with different remote controls, the loaded file is the one that corresponds to the remote control being used. If the parameters have been backed-up several times at different dates, the last backup will be loaded.

Save and restore WPC files {5050}

Backup of WPC configuration {5017}

This function writes the operational configurations on to the SD card of the WPC. You can use this function to do a backup of the remote control parameters or to visualize on a computer the values that you have selected.

The file in CSV format is written in a directory called CSVFILES\« FID »\DATE.

The directory FID indicates the unique identification of your WPC and contains the subdirectory which indicates the date of backup.

Loading the WPC configuration {5018}

Reload the WPC configurations. If several files have been created with different WPC's, the loaded file is the one that corresponds to the WPC being used. If the parameters have been backed-up several times at different dates, the last backup will be loaded.

INSTALLER - Create a master file {5033}

This function allows you to create a reference file to parameter the installations-type.

This function is used to do a setting only one time and to put it further on several WPC's or installations.



You only can create one master file by SD card.



Loading a master file {5034}

If your installer provides you with a file of parameters for your installation, you can load it by means of this menu. Insert the SD card and launch the loading by pressing the key SET. Caution, the various operations carried out by this process take some minutes.

Load WPC parameters preset {5045}

Libraries of predefined parameters are available for specific applications (such as Solsafe). From this menu you can load one of these libraries. You can also combine various libraries.



If two or more libraries handle the same parameter, the value of the last library loaded is used.

ADJUSTMENT OF THE CONTRAST {5006}

The adjustment of the contrast allows the display to be adjusted in terms of lighting and to a reading position that allows excellent visibility.

ADJUSTMENT OF THE BACK-LIGHTING {5007}

Back-lighting always off {5008}

This adjustment allows you to activate or deactivate the back-lighting. Its activation gives access to an additional configuration that is the duration of the back-lighting.

Duration of the back-lighting {5009}

This configuration allows you to determine after how much time of inactivity the back-lighting will switch off.

Red back-lighting if the WPC is OFF and if there is a fault {5026}

If the WPC is stopped by a fault (battery undervoltage, overload, etc.) the back-lighting flashes red.

INACTIVITY PERIOD BEFORE RETURNING TO THE STANDARD DISPLAY {5010}

This configuration allows you to determine the time after which the display returns to the basic display if no key is pressed.

DURATION OF DISPLAY FOR QUICK MESSAGES {5011}

Messages of low importance are displayed for a limited period. This adjustment enables you to adapt this duration at your convenience.

ACOUSTIC ALARM {5027}

In the event of an alarm an acoustic signal is activated. You can always deactivate this signal by using this configuration.

REMOTE CONTROL ACOUSTIC ALARM DURATION {5031}

This parameter enables to adjust the remote control acoustic alarm duration (in seconds).



SWITCHING ON AND OFF OF SYSTEM ON LEVEL VIEW ONLY {5056}

If this parameter is deactivated, it is not possible anymore to put the installation ON or OFF with the remote control, should it be at level « view only ».

CHOICE OF THE DISPLAY BY DEFAULT {5073}

With this parameter you can choose the display by default that comes up when exiting from a menu or while connecting the remote control.

INFORMATION ON OPERATING THE INSTALLATION

There are two different views for displaying information on the system :

A simplified and a configurable display. When one of these two displays is visible, it is possible to activate or deactivate the system. For further information, please refer to the paragraph on activating and deactivating the combi WPC.

The simplified display only indicates the current time and the mode of the WPC (ON or OFF)

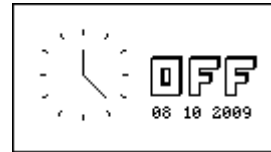

The configurable display shows the system in its entirety, represented by a synopsis of distinct information blocks.

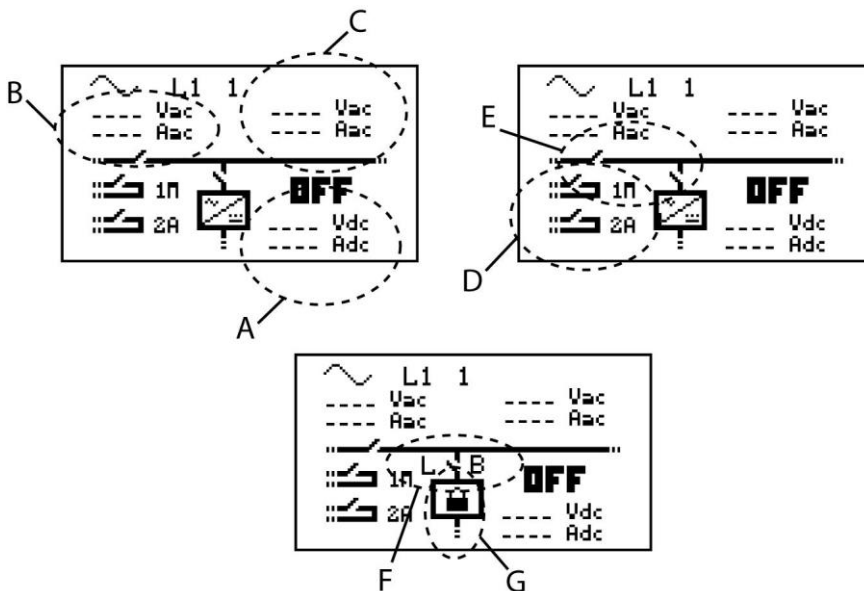

- A Information on the battery
- B Information on the grid input
- C Information on the grid output
- D Information on the auxiliary contacts
- E Information on the transfer and output relays
- F Information on the state of the maximum current of the source (Input limit) (L) and of the Smart-Boost (B: Boost activated, L: input limited)
- G Information on possible locking of the function (G)

Two pieces of information related to blocks A, B and C may be viewed simultaneously. To change displayed information, proceed as follows:

Press the key SET (one of the pieces of information is displayed in reverse video).

Go to the value to be changed by using the UP and DOWN keys.

Enter into modification by using the key SET. You may now view the values that can be displayed in this area.

Using the keys UP and DOWN, select the new information that you want to see appearing.

Confirm your selection by using the key SET.

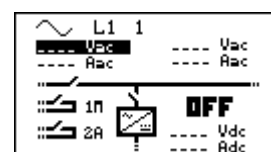

To escape at any time, use the key ESC to return to the starting display.

With regard to the grid input

- AC In input voltage
- AC In input current
- AC In input power
- Input frequency
- The value of the source max current (Input limit)
- Energy from AC-In of the previous day
- Energy from AC-In of the current day

With regard to the grid output

- Output voltage
- Output current
- Output power
- Output frequency
- Consumers energy of the previous day
- Consumers energy of the of the current day

With regard to the battery

- Battery voltage
- Actual charge current of the batteries
- Programmed charge current
- Ripple voltage of the batteries
- Charging phase (bulk charge, absorption, float charge, etc.)
- Dynamic compensation of the battery (compensation of the thresholds due to the internal resistance of the battery)
- Operating mode (inverter, charger, etc.)
- Battery temperature (if a sensor is present)
- The battery temperature's inherent compensation (if a sensor is present)
- Discharge of battery of the previous day
- Discharge of battery of the current day
- Remaining time of the phase of absorption, equalization or reduced absorption
- State Of Charge of the battery (SOC) (if a BSP is present in the system)

If a piece of information is not available, the screen displays - - - -.

Information on the auxiliary relays as well as the output and transfer relays appears as open or closed in the synopsis according to their current state.

Auxiliary relays are indicated with their corresponding number as well as the letter A if they are operating in automatic mode and M if they are controlled manually.

Other letters may be displayed with regard to specific programming. Please refer to the corresponding chapter.

The general operating mode of the WPC is displayed in large letters on the two visualisation screens (ON or OFF).

DISPLAY OF THE PARALLEL AND THREE-PHASE SYSTEMS

While using several WPC's in parallel or in three-phase, an additional view is available. This view summarizes the various electrical values of the system. Like for the display of a system with one single WPC, you can access to the displayed values in order to modify them.

Each summarized view gives access to the display of one WPC.

In the view of the three-phase, you have access to the detail of one phase by pushing the key SET and then, by pushing UP or DOWN, you can choose the phase you want to see displayed in details.

If the phase consists of several WPC's in parallel or if the system is a single phase one but with several WPC's in parallel, you can then have access to the display of each WPC by selecting in the view parallel one of the three available inverters.

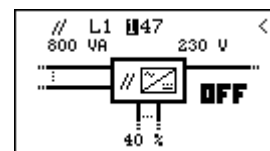
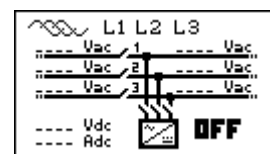

MESSAGES AND ACCOUNT OF EVENTS

This screen allows you to view the various events that have occurred in the installation.



The events that occur in your installation are displayed on the remote control screen. The events are classified within two categories:

The events that may have serious consequences are displayed up to the moment where the user confirms that he has taken note of them by pressing on an RCC/PSCP remote control key. These events are recorded in the event history and may be consulted subsequently.

Events not posing a risk are indicated briefly on the display and then disappear. Some are recorded in the event history.

On the other hand, the messages may have different origins and they are preceded by an attribute to enable you to understand the importance:

Message : normal event but one that conditions or influences the operation of the WPC.

Error: an event that prevents the correct or normal operation of the WPC.

Alarm: an event that may cause a malfunction of the installation if it is not corrected.

Stop: The system had to be stopped as a major event is preventing its operation.



Caution, a stop can be temporary and the system can restart automatically. In case of work on the installation, switch off the system.

INSTALLER - In the message history, you may clear the list of saved messages. The clear function is signalled by 'CLR', opposite the SET button. You must confirm to clear the list of messages.



Use this function, for example, after maintenance visit or when completing the commissioning of the installation.

(000) ALARM: LOW BATTERY VOLTAGE

The battery is almost completely discharged. If the situation persists, the inverter function of the WPC will be deactivated.

Solution:

- recharge your battery as soon as possible
- recharge your battery more frequently
- increase the power or the energy available for the load (for instance with more solar panels)



This message is generated in conjunction with the undervoltage of the battery configuration {1108} and not with acoustic alarm {1196}.



The service life of the batteries is greatly conditioned by their state of charge. Prolonged or repeated operation at a low charge may cause damage. With the Smart-Boost function activated, it is also possible to discharge the batteries even if connected to a source of energy.

(003) MESSAGE: AC IN SYNCHRONIZATION IN PROGRESS

A valid voltage has been detected on the AC IN input and the WPC is synchronizing. Once synchronized, the consumers will be transferred to it and the battery will be charged.

	Note: It is possible to prohibit the transfer or the battery charging.
---	--

(004) MESSAGE: WRONG AC-IN INPUT FREQUENCY

The voltage at AC IN does not have a frequency included in the admissible range for the WPC.
 Solution: When operating on a generator, check its speed.

	If you are not equipped to measure the generator frequency, measure its voltage with no load. Indeed, if the voltage is correct, the frequency is generally correct as well. If the voltage decreases very much at an increasing load, this will also be the case with the speed (RPM) = frequency of the generator. The decrease of RPM of an engine under load is often caused by lack of fuel due to choked filters.
---	---

(006) MESSAGE: TOO HIGH AC-IN INPUT VOLTAGE

The voltage at the AC IN is too high for the WPC and represents a danger for the consumers; the transfer relay is not activated.

Solution: Reduce the voltage on the AC IN input to come into an admissible range.

(007) MESSAGE: TOO LOW AC-IN INPUT VOLTAGE

The voltage at AC IN is too low for the WPC. The transfer of consumers and battery charging are not activated.

Solution: Reduce the voltage on the AC IN input to come into an admissible range.

	Do not increase the voltage of the generator during the battery charging or when the consumers are connected to it: If the consumers stop, an overvoltage may arise which will destroy components of your installation.
---	---

	If the transfer of the consumers is carried out and the message appears some seconds after the start of the battery charging, check that you have not adjusted the charging current of the batteries too high in relation to your source. Also check the adjustment of the maximum current of the source (Input limit) configuration {1107}.
---	---

(008) STOP: OVERLOAD INVERTER SC

The consumers require more power than the WPC inverter can supply.

Solution:

- Adapt the maximum power output of your consumers to the maximum power output of the WPC
- . Check that the cabling is not short-circuited.

(014) STOP : OVER TEMPERATURE EL

The WPC stops due to overheating.

Solution:

- Check that the ventilation holes of the WPC are not obstructed.
- Check that the WPC is not situated in a place where the ambient temperature is too high.
- Adapt the power max. of the users to the nominal power of the WPC according to the ambient temperature.

	The over temperature is disadvantageous for the service life of certain electronic components. If the stoppages due to over temperature happen frequently, corrective measures will be required.
---	--

(015) STOP: OVERLOAD INVERTER BL

The users need more power than the WPC inverter can supply.

Method:

- . adapt the power max. of the users to the power max. of the WPC.

(016) ALARM: VENTILATION FAULT DETECTED

A dysfunction of the ventilation has been detected, get it checked by a technical staff.

(018) ALARM: EXCESSIVE BATTERY ONDULATION

The voltage ripple at the battery cables is too high.

Solution:

- Check that the battery cable section is correct.
- Check the tightness of the battery cables.
- Check that the charge current matches your battery.
- Check the state of your batteries.



The use of batteries of an inappropriate capacity may also cause this error message. In this case, reduce the charge current or lower the power output of the consumers.



The voltage ripple on the batteries may be caused by their ageing. In this case, lower the charge current.

(019) STOP: TOO LOW BATTERY VOLTAGE

The functions inverter and Smart-Boost of the WPC are deactivated because the batteries are discharged.

Method: recharge your batteries to reactivate these functions automatically.

(020) STOP: HIGH BATTERY VOLTAGE

The voltage of the battery at the WPC DC input is too high. The system is stopped for security reasons.

Method: check that the battery nominal voltage suits the WPC one.

In case of an external charger, check that it charges the batteries with a voltage suitable for the WPC.

(021) MESSAGE: MAXIMUM CURRENT OF THE SOURCE (INPUT LIMIT) EXCEEDED; TRANSFER PROHIBITED

The power output of the consumers exceeds the one specified for the source, and the transfer relay cannot be activated. The WPC operates in inverter mode.

- This situation occurs only if you have deactivated the parameter {1436} Solution:
- Check that the configuration of the maximum current for the source {1107} corresponds to the maximum current of the source connected at AC In.
- Reduce the number or power output of the consumers.



In this case, the transfer relay is not activated and the recharging of the batteries cannot take place. If this situation continues, you might discharge your batteries.

(022) ERROR: VOLTAGE AT AC OUT

An unwanted voltage is present at AC Out.

Solution:

- . check that you have not reversed the cabling of AC input and output.

- . no source must be connected to the WPC output (AC-Out).
- . check the cabling of the installation.

(023) ERROR: PHASE NOT DEFINED

The jumper of phase selection (L1, L2 ou L3) is missing on the WPC.
The WPC cannot operate without the phase being defined.

Solution: Check the phase definition jumper in the cable connection zone.
Refer to the WPC manual for more information.

(024) MESSAGE: CONTROL THE BATTERY OF THE CLOCK

The maintenance battery is discharged. To avoid the clock goes back to zero in case of a blackout, its replacement is necessary. Refer to the WPC manual for this replacement.

(041) ALARM: OVER TEMPERATURE TR

The temperature of the WPC is excessive and the output power is limited.



Check that the ventilation around the WPC is not impeded.
This message can also occur after a long operation in a too hot environment.

(042) STOP: SOURCE AT THE OUTPUT

A source of energy has been detected at the AC-Out output and supplies current to the WPC.
Method: check that you do not have a source of energy connected to the output.



Back feeding is not facilitated; Consult your supplier

(058) ERROR: LOST OF SYNCHRO MASTER

A communication problem between the WPC's is detected.
Method: check the cabling in between the WPC's.

(059) STOP: OVERLOAD INVERTER HW

See code (015)

(060) (061) ALARM: MAXIMUM DURATION SECURITY FOR AUXILIARY CONTACT

The maximum duration that you have selected for the relay activation with the parameter {1514}, {1515} is reached and the activation conditions are still present. The contact will not be reactivated as long as the conditions are present. Therefore there is a risk that the auxiliary contact remains locked in this position unless you reset this alarm.

Method: reset manually this alarm with the corresponding parameter ({1512}AUX1, {1513}AUX2) by deactivating and then activating it.



Use this function with care and only as a security.



STORED EVENTS

Events are stored in the remote control. Any system not permanently connected to a remote control does not store the events.

To access the event history via one of the basic displays, change the screen by using the keys UP and DOWN until the “event history” screen appears and then validate using the key SET.

The number shown at the top right indicates the message number. In a system with several WPC's, the events are presented in chronological order and the lower line indicates the WPC to which the event refers.

Each event is recorded as well as the date and time of its occurrence. The keys UP and DOWN allow you to view all the events that have occurred.

Where there is a system with multiple WPC's, each message also contains the number of the WPC that has generated the message.

Quit the message display by using the key ESC.

```
History 0021
12h03 06.01.2000
Error : Input
voltage too low
Inverter 1
```



These messages can be exported on a SD card, which allows their transmission or their use on a computer..



DATA LOGGING

The remote control WPC-RCC/PSCP offers a function that allows to record many electrical values of your system over a long time.

With this function you can for instance follow the energy consumption and the battery voltage, or see the power cuts, the state of the auxiliary relays, the input currents and voltages, the output powers etc...

This enables you to work out statistics, to check the system operation or its sizing, to verify the loads behavior, to anticipate or to detect failures.

FUNCTIONING

If the data logger is activated, a file is created at midnight every day on the SD card inserted in the remote control. This file contains the data of the WPC system components as well as the recordings of the system electrical values, minute after minute. The file is registered in CSV format that can be read by many software. The file name integrates the date of the measure in this form: LGaammjj.csv. In case no SD card was inserted, the daily data will be lost.

If the data of the current day have to be available for analysis, it is possible to create a file manually during the day with the data already available.

The remote control software updating will lead to the erase the daily data.

SETTINGS OF THE WPC

A complete list of the accessible parameters can be found at the end of this manual.

GENERAL

The WPC inverter/charger has been designed to ensure that all basic functions of an energy management system work completely independently. In its original version, no adjustment is usually required.

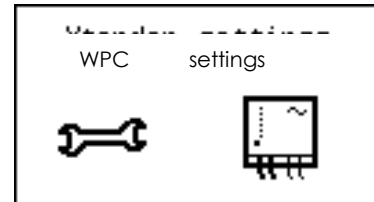

Caution, a hazardous setting of the parameters may lead to a malfunctioning of the whole installation, or event to damaging it.

Nevertheless, in certain installation conditions, it may be necessary to adjust some operating configurations. This is why the RCC/PSCp remote control gives access to the adjustment of many configurations and within a range largely exceeding the usual values. Use these adjustment options with care and only with due specialist knowledge. Changing configurations is not the responsibility of WhisperPower. Please refer to the chapter on limitation of responsibility for more information on this topic.

CONFIGURATION ON A SYSTEM WITH SEVERAL WPC'S

When there is a system to which several WPC's are connected, the changing of a configuration is global. It will be applied to all the WPC's connected together. To carry out adjustments on a single WPC, it is necessary to remove the connection cables and only keep the connection between the remote control and the WPC on which the different adjustment is being carried out. It is thereby possible to configure each WPC of a system independently. Once the configuration has been carried out, the original connection can be re-established.



Note: If you have carried out an individual configuration, once a configuration has been changed, the system reconnected by the data connection cable modifies this configuration for all the WPC's connected.



Caution, in case of different connection of the devices, the rule regarding terminations must be applied.

UTILISATION AND ACCESS LEVELS

The functions described below refer to the EXPERT level. Depending on the user level selected, access to all the functions may not be possible. Refer to the chapter on setting the user level of the remote control for more information on this subject.

ACCESS TO THE PARAMETERS

You can access to the parameters by two different ways:

- By its reference number;
- Via the thematic menu.

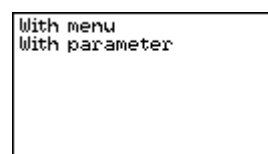

Access to a parameter by its number

Each WPC parameter is directly accessible by its unique reference number. This function can be used in order to change the value of a parameter or to consult its set value.

If you know the reference number of a parameter that you want to change, you can access to it directly with this menu. Move with the keys UP and DOWN to highlight the parameter then select it by the key SET. You have then the possibility to change the value of this parameter.

For each parameter, its set value is written opposite to it. If a parameter does not have a value displayed, this means that you do not have the user level required to change the value or that the parameter does not have a value (a menu title for instance).

When you want to access to a parameter which access level is superior to yours, it is possible to do it only with a code: select the parameter that you want to change with the keys UP and DOWN then press the key SET. The remote control then displays a 4 digits number. By communicating this number to your installer, you can receive an activation number which will allow to modify the wanted parameter.

The key received is valid only for one single access to the wanted parameter. This is why it can be necessary to be online with your installer when it comes to do several changes.

Access to a parameter via the menu

The WPC configurations are divided into several categories:

- Basic configurations
- Battery and its charge cycle configurations
- Inverter configurations
- The parameters of charger and input signals
- First auxiliary contact configurations
- Second auxiliary contact configurations
- Auxiliary contact extended function configurations
- The parameters of the system
- Three-phase or parallel operation configurations
- The parameters of grid feeding

According to the user level selected, it is possible to access several hundred configurations. For this reason, each configuration has a unique ID displayed top right. In the event of questions on the subject of a configuration, ensure that you have this number at hand.

When you modify a configuration, a star is displayed to the left of the value if it corresponds to the factory-set value.

The various configurations can be adjusted within a large range. Nevertheless, some configurations are interdependent and cannot be adjusted beyond the value of other configurations. You can consult the list of dependencies on the list in appendix 1.

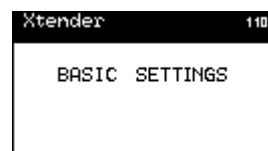

INSTALLER - UTILISATION AND ACCESS LEVELS

The configurations of the WPC are defined by the following elements:

- The minimum
- The value
- The maximum
- The user level necessary to access it



When in client mode (Basic or Expert), the remote control gives access to the different configuration values. In INSTALLER or installer mode, you have access to the other elements. This means that you can define the minimum and the maximum of **each setting**. The values remain limited, however. You can also determine the minimum access level for each parameter.

If the element is preceded by a star, it means that it is the same as the factory setting.

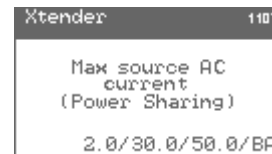

When you access a setting for modification, you can adjust successively the minimum, the default value, the maximum, and the user level necessary to access each setting.



The user level is represented by an abbreviation. You can make the setting accessible from BASIC, EXPERT, Installer, or INSTALLER level.

Use the following values for the levels:

Accessible to Basic level: BA

Accessible to Expert level: EX

Accessible to Installer level: IN

Accessible to INSTALLER level: QS



Use this function if you wish to remove the possibility for clients to set a parameter of the WPC.

BASIC CONFIGURATIONS {1100}

The basic configurations serve to adapt the WPC characteristics to the elements that surround it. Use these configurations in order to optimize the operation of the inverter/charger and to benefit from the maximum performance of your installation.

Maximum current of the AC source (Input limit) {1107}

Adjust this configuration in the event of connection to a limited power source, for example, a generator of moderate power output or a dock or camping connection. The adjustment of this value limits the instantaneous power consumed from the source in charger mode. The power available is attributed by first priority to consumers and then to battery charging. If the consumption level changes, the battery charge current is automatically adjusted.

- A. Power available and used to recharge the batteries
- B. Maximum AC source current (adjusted to 10 A here)
- C. Consumer current
- D. Power supplied by the inverter (Smart-Boost function)

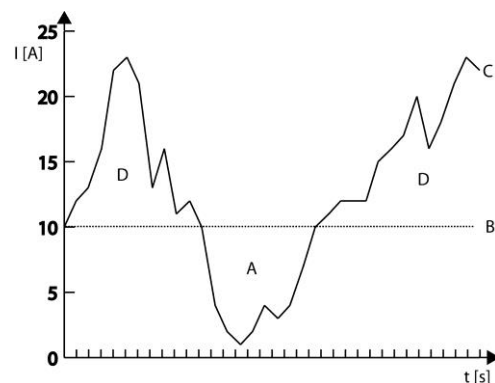

If the consumption level is higher than the controlled level, the maximum source current will be exceeded, except when the Smart-Boost function is activated.



It's possible to access faster to this function, please refer to the page 17

Charge current {1138}

Use this value in order to adapt the charge current to the battery. With this configuration, the maximum current to be used for charging your battery is adjusted. The current appropriate for the battery can be found in its technical data. The value set by this configuration is used during the whole bulk charge phase.



Use this setting to adapt the charge current only with regard to the battery. To adapt the charge current to your source, use the parameter for maximum current at the source (Input limit) {1107}.
The right setting of these two values is essential for correct operation as well as the lifetime of your installation.

Smart boost authorized {1126}

The function Smart-Boost is deactivated by default. In this case no assistance will be provided to the source and if the source is overloaded, the energy from the battery is not drawn. Do authorize this function if you have a low power source (generator, shore power or camping plug) and you want more power to be available.



When the Smart-Boost function is active, it is possible to discharge the batteries, even if the WPC is connected to a source and the charger is active.

Authorized inverter {1124}

This configuration authorizes operation in inverter mode. If the inverter is deactivated, a voltage will be present on the output terminals (AC OUT) only if a correct voltage is present at the input (AC-in) and the transfer is not prohibited.



This function can be used for supplying non-critical consumers while ensuring that the battery is not discharged even if the source is faulty.



Note, that if the Smart-Boost function is activated, it is possible to discharge the battery even if the inverter function is locked.

Where there is lock on the inverter, charger or transfer function, a small padlock is displayed on the configuration display.

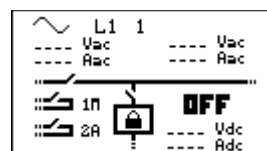

Type of detection of AC input loss (UPS) {1552}

With this parameter it is possible to set the sensitivity at the WPC input (AC in) such that it can tolerate large fluctuation in the AC input voltage (setting Slow), moderate fluctuation (setting Tolerant) or act as a UPS (setting Fast).

Standby level {1187}

The standby function allows energy to be saved if there is no consumer present at the inverter output. In this case, the inverter disconnects its output and periodically emits a load search pulse. If a consumer is detected, it goes back into operational mode while measuring the power supplied and returns to standby if the consumer is deactivated.



This configuration allows adjustment of the power output at which the inverter goes into standby mode. Proceed as follows to adjust this configuration:

Make sure that the inverter mode is active (no voltage present at the AC In input). The input voltage is 0 and the input relay is indicated as open in real time on the information screen.

Increase the standby level value {1187} to the maximum

Activate the smallest consumer that can be detected and ensure that all the others are deactivated.

Wait for the inverter to pass to standby, and the consumer then engages intermittently around once a second.

Progressively reduce the standby level value {1187} until the consumer runs permanently. If the consumer works for several seconds then stops, decrease the value of the standby level again.

An adjustment value between 0 and 100 is displayed. The value 100 represents the minimum sensitivity (biggest consumer detected).



If you would like to deactivate the standby function, it is sufficient to adjust the detection level to 0. In this case, the WPC remains permanently activated if it is working in inverter mode.

Restore default configurations {1395}

Use this function to re-establish the original WPC adjustments.



If your installer has carried out settings while commissioning your installation, this function brings back these settings and not the factory settings.

INSTALLER - Restore factory settings {1287}

This function allows you to go back to the settings which were set at the factory. For each setting, not only its factory value is restored, but also its limits and its user level.

When the factory settings are restored, the WPC programme shuts down and restarts, like when it is switched on (reset).

MANAGEMENT AND BATTERY CYCLE {1137}

These configurations are intended to adjust the battery charge cycle to the data supplied by its manufacturer. The basic battery cycle is described in the WPC manual.

	<p>Note: Incorrect values may lead to early ageing or even the destruction of the batteries.</p>
--	--

For further information, contact your battery supplier who will give you the correct values. The graphic presentation of the battery cycle shows the options for linking the various phases:

Minimum battery cycle

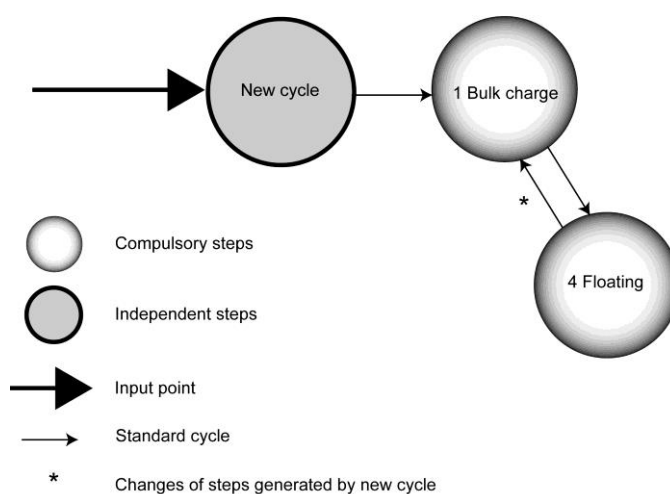

The bulk charge and floating phases cannot be deactivated. If the conditions for starting a new battery charge cycle have come together, the bulk charge phase starts immediately.

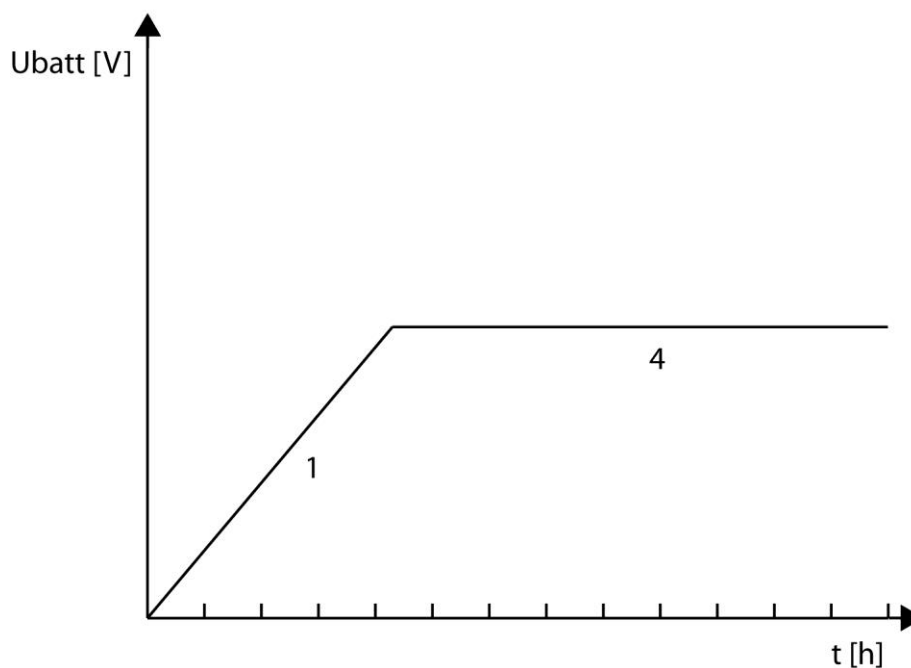

Default battery cycle

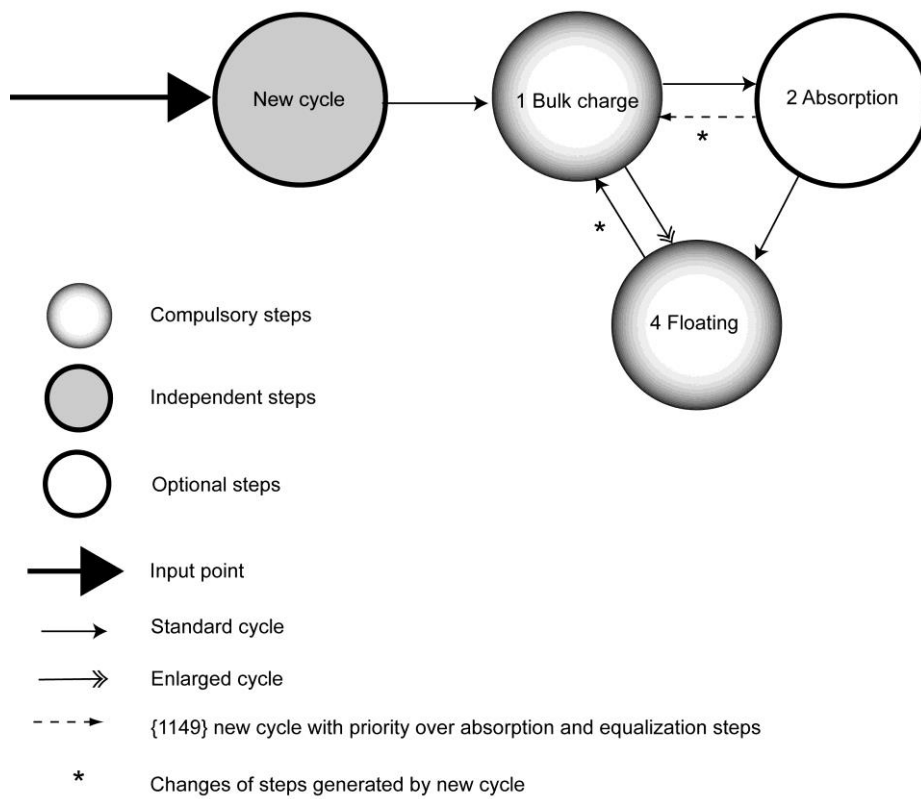

The battery cycle fits a large number of batteries by default, irrespective of whether they are gel batteries or not.

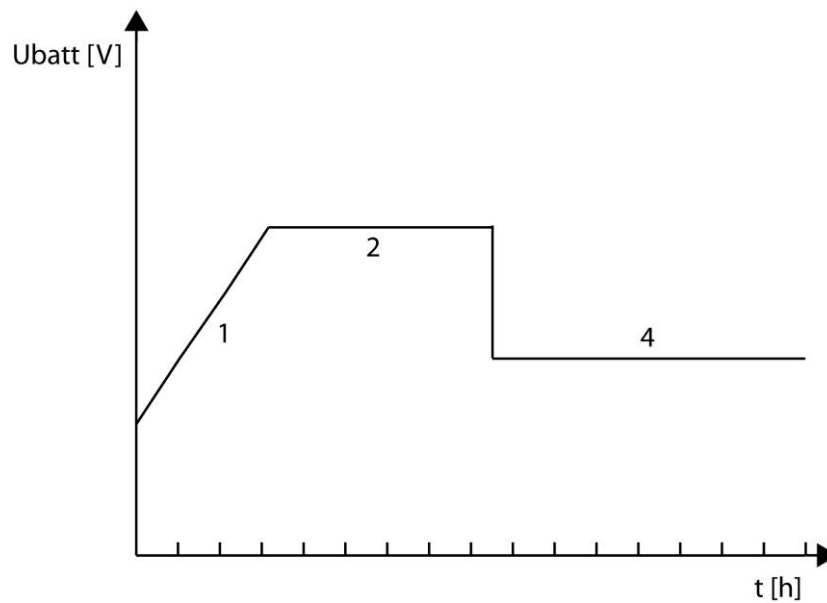



Complete battery cycle

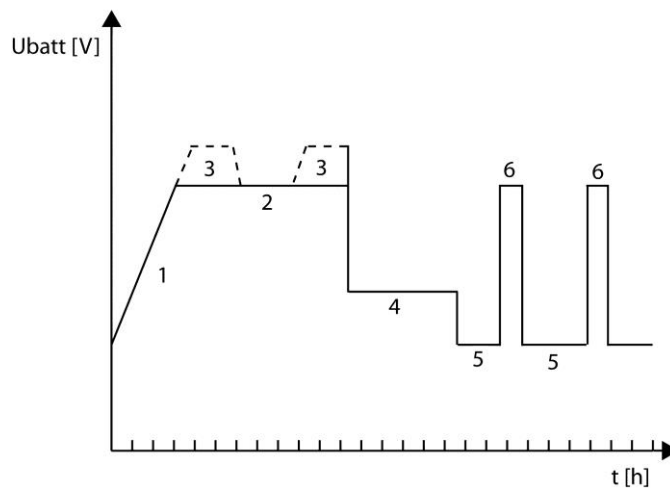
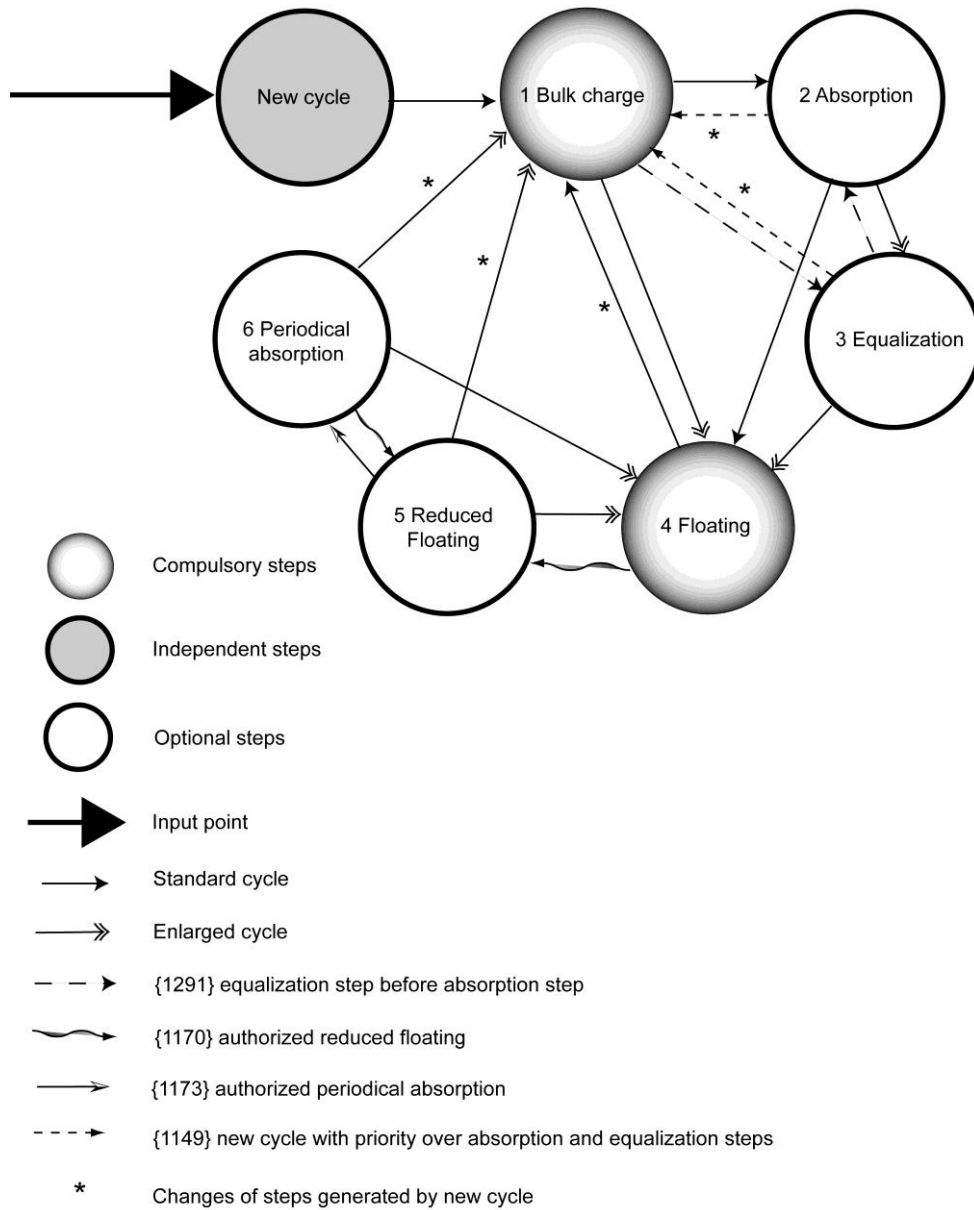

Authorized charger {1125}

The battery charger function is either activated or not. If this function is not authorized, it is necessary to charge the batteries using a source of energy not connected to the WPC.

Where there is lock on the inverter, charger or transfer function, a small padlock is displayed on the configuration display.

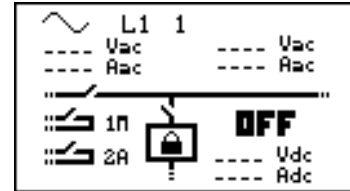

Charge current {1138}

Use this value in order to adapt the charge current to the battery. With this configuration, the maximum current to be used for charging your battery is adjusted. The current appropriate for the battery can be found in its technical data. The value set by this configuration is used during the whole bulk charge phase.

	<p>Use this setting to adapt the charge current only with regard to the battery. To adapt the charge current to your source, use the parameter for maximum current at the source (Input limit) {1107}. The right setting of these two values is essential for correct operation as well as the lifetime of your installation.</p>
--	---

	<p>If you don't have any indication of the charge current, the most commonly used value is a fifth of the capacity. Ex. for 500Ah : $500/5 = 100A$. Caution, if your batteries are in series, the capacity for the formula above is only that of one battery and not the sum of them. If they are in parallel you MUST take the sum.</p>
--	---

Temperature correction coefficient {1139}

If a battery temperature sensor is used, the charge and discharge voltages are automatically adapted to the temperature of the batteries. The compensation is given in millivolts by degree Celsius ($^{\circ}C$) and by battery cell. The discharge thresholds are not compensated.

Under voltage {1568}

Level of battery under voltage at no load {1108}

Allows adjustment of the battery's low voltage level at which the inverter and Smart-Boost functions are deactivated. This adjustment is applied in the case of a zero charge and is automatically adapted with regard to the power required from the batteries. This configuration is a factory setting for lead-acid batteries. Poor adjustment of this value leads to early ageing of the batteries due to deep discharges.

- A. Battery voltage.
- B. Duration of under voltage before disconnection {1190}.
- C. Disconnection due to under voltage.
- D. Under voltage level {1108}.

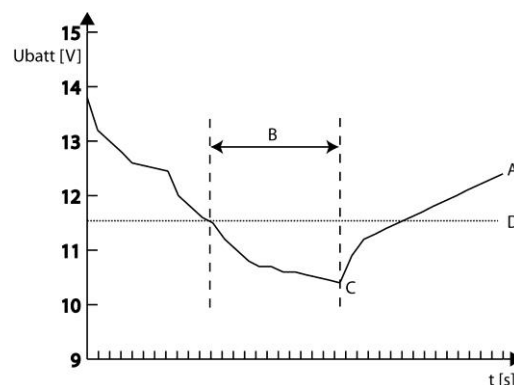

Adjust this configuration using the technical data for your battery.



The battery under voltage level is automatically adapted to the instantaneous power of the consumers to compensate for internal losses in the battery and cables.

Dynamic compensation of the batteries under voltage {1531}

Dynamic battery under voltage compensation {1191}

This setting allows you to activate (or not) the dynamic battery under voltage compensation. If this setting is deactivated, the disconnection voltage is identical, whatever the charge on the inverter of the WPC.

Type of dynamic compensation {1532}

This parameter enables you to choose between an automatic or a manual dynamic compensation. If you use the manual compensation, you must adjust the parameter {1109} under voltage at full load.

Low voltage disconnection at full-load {1109}

The battery under voltage is adapted to the nominal current of the inverter (dynamic under voltage compensation). You can adapt the disconnection voltage to the nominal charge of the inverter, according to your battery specifications.

Duration of under voltage before disconnection {1190}

If the battery voltage is beneath the disconnection threshold, the inverter and Smart-Boost functions are deactivated, but not immediately. This setting allows you to adjust the delay between falling below the disconnection threshold and the current disconnection. This allows the batteries to recover from possible short peak loads.

Reactivation voltage after battery under voltage {1110}

When the WPC has shut off the inverter function following a battery under voltage, it starts up again if the battery voltage returns to acceptable value. This setting allows you to fix the voltage at which the inverter and Smart-Boost functions are reactivated.

Acoustic alarm of the battery under voltage {1196}

When the battery is discharged, the inverter stops in order to protect it from deep discharge. Before disconnecting, the inverter indicates this state via a message and activates the acoustic alarm. The alarm goes out when the inverter stops or after a defined duration {1469}.

Adaptable low voltage disconnection {1194}

A battery permanently operating when it is practically discharged sees its lifetime drastically reduced. In order to force the client to recharge the battery, the under voltage threshold may be increased with each under voltage disconnection. The low threshold is increased with each disconnection, and returns to its original value if the battery has been recharged up to a certain voltage. For this reason, the client will not be able to constantly discharge the battery without at least having recharged it.

Adaptable battery low voltage disconnection maximum voltage {1195}

The under voltage threshold is increased with each under voltage, but no higher than the value fixed by this setting.

Reset voltage of the adaptable correction {1307}

The battery under voltage threshold returns to its original value if the battery reaches the voltage determined by this threshold.

**Increment of the adaptive correction {1298}**

At each shut down by under voltage, the shut down threshold is increased by this value.

Maximum operating voltage {1121}

This setting allows you to adjust the maximum battery voltage for operation in inverter mode.

Reactivation voltage after battery overvoltage {1122}

In case of a battery overvoltage, the battery has to return to a voltage lower than the value fixed by this setting in order to unlock inverter operation. If the auto-restart after overvoltage function is activated, the WPC will automatically restart once the battery voltage has gone beneath this value.

Battery maintenance voltage (floating) {1140}

Use this configuration to adjust the voltage that will be used when the battery is completely charged. This voltage prevents automatic discharging and maintains the battery at its maximum level of charge.

Force passage to floating mode {1467}

This configuration may be used to force a battery cycle in progress and to bring it to the end of charge values. If the battery voltage level is higher, the charger is temporarily disconnected. If the battery level is lower, the charging current is increased up to the maximum in order to reach the set level as quickly as possible.

New cycle {1141}

Battery charging is a complex function that generally ends with a maintenance phase (floating) of indeterminate duration. The configurations below allow adjustment of the conditions that lead to the starting of a new charge cycle.

Force new cycle {1142}

This configuration allows a new charge cycle to be forced, and the bulk phase follows straight away.

Voltage 1 for a new cycle {1143} and duration at under voltage 1 for a new cycle {1144}**Voltage 2 for a new cycle {1145} and duration at under voltage 2 for a new cycle {1146}**

The battery voltage value, below which a new cycle is started, can be specified. The battery voltage must remain below this threshold for the duration that is also to be determined. Two voltages associated with two durations are configurable. Generally, a higher voltage is used with a longer duration and a lower voltage with a shorter duration.

New priority cycle on the absorption and equalization phases {1149}

Activate this configuration to accept or interrupt the absorption and equalization phases to start a new cycle. In the opposite case, even if the conditions are fulfilled for starting a new charge cycle, the battery charging proceeds normally by following the programmed phases.



In the event of battery charging with renewable energy sources such as solar energy, for example, this configuration must remain deactivated (*no) in order to avoid cycles taking place too frequently.

Restricted maximum cycle frequency {1147}

Minimum duration between cycles {1148}

If you wish to limit the frequency of the charge cycles, this setting allows you to lock the system so that a new battery charge cycle will not be initiated, even if the conditions for doing so have been met. The duration of the lock does not depend on the duration of the cycle. It takes into account the duration between the start of each cycle.

- A: New cycle
- B: Presence of AC-In source
- C: Floating voltage

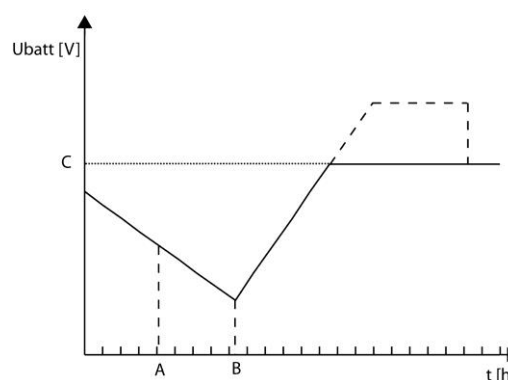

If you activate this function and you adjust the duration setting to 24h, you will only have one charge cycle per day. In this case, if the conditions for a new cycle are met, the cycle will not take place and the charger will keep the battery at floating voltage.

Absorption phase {1451}

During this phase, the battery accumulates the final percentages of the energy it is storing. This phase is carried out with a constant voltage.

Authorized absorption {1155}

This configuration determines whether or not the absorption phase is used. If this phase is deactivated, the charger goes directly to the authorized phase that follows it.

Absorption voltage {1156}

Use this configuration to adjust the voltage that is used for the absorption phase.

Duration of absorption {1157}

Use this configuration to adjust the duration of the absorption. The absorption phase starts once the set voltage {1156} is reached. When the duration has run out, the charger automatically goes to the authorized phase that follows it.

Completion of absorption released by the current {1158}

The absorption phase may be interrupted if the battery charge current automatically passes below a certain threshold. This may be used in order to limit the duration of the operation of a generator while there is an acceptable battery charge.

	During the absorption phase, as a matter of fact, the charge current reduces progressively. If the bulk charge has been carried out with a current which is correct for the battery, it is not necessary to adhere to a fixed duration to end the charging.
--	---

Current at end of absorption {1159}

Set the current value below which the absorption phase is considered to be at an end. When the current of the charger goes below this value, the next step starts.

Control of the maximum frequency of the absorptions {1160}

Minimum duration since the last absorption {1161}

These parameters enable to limit the frequency of the absorptions. You can freely set the period during which no further absorption will be carried out. If a new battery charge cycle is activated, the battery will be charged until absorption voltage, but once this voltage is reached, the battery charging will go automatically to the next phase (usually floating).

- A: New cycle
- B: Presence of source
- C: Floating voltage
- D: Absorption voltage

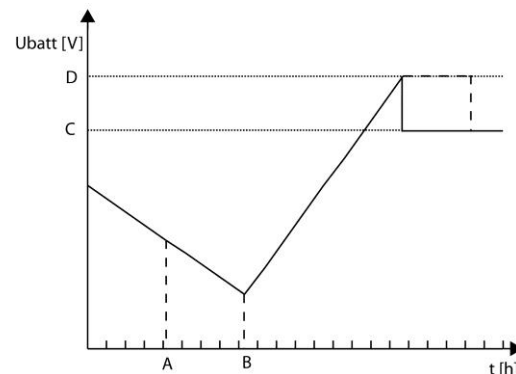

Equalization phase {1452}

Certain types of battery require equalization in order to avoid the stratification of water and acid that they contain. Use the configurations below in order to adjust the usage conditions for this charge phase.

	During an equalization phase, a large quantity of gas is released that is highly explosive (hydrogen). Ensure that you adhere to the battery manufacturer's instructions for this function. In all cases, ensure that there is sufficient ventilation around the batteries.
--	---

	During the equalization phase, the water of the battery is separated into gases (hydrogen and oxygen) and this action serves to decrease the level of liquid in the batteries. Check their level regularly.
--	---

Authorized equalization {1163}

This configuration determines whether or not the equalization may be used on the installation.

Force an equalization {1162}

Use this configuration to force the start of an equalization phase.

	It is only possible to force an equalization phase if the equalization is authorized. Once the phase has started, prohibiting the phase does not stop the equalization. To stop the equalization, use Force passage to maintenance (floating) or Force new cycle.
--	---

Equalization before absorption phase {1291}

This configuration determines in the charge cycle, in which equalization will be activated, if the equalization is carried out after or before the absorption phase. The equalization phase is carried out before the absorption phase by default.

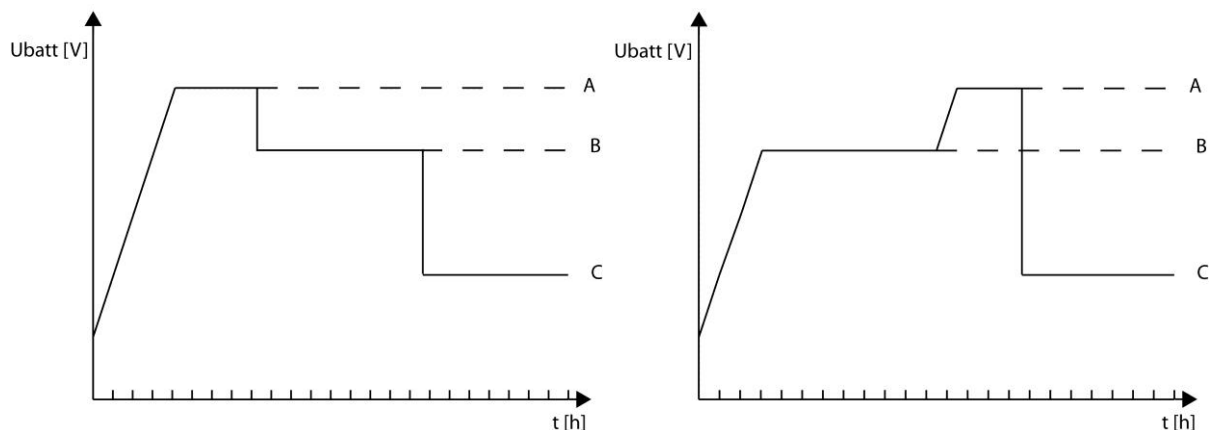

- A. Equalization
- B. Absorption
- C. Floating

Equalization current {1290}

The equalization phase can be carried out with a limited current, which can be adjusted using this configuration. In all cases the current does not exceed that of the bulk charge phase {1138}.

Equalization voltage {1164}

Set the voltage at which the equalization is carried out using this configuration.

Duration of equalization {1165}

Use this configuration to adjust the duration of the equalization. The equalization phase starts once the set voltage {1164} is reached. When the duration has run out, the charger automatically goes to the authorized phase that follows it.

Number of cycles prior to equalization {1166}

Equalization is not carried out at each charging cycle. This configuration allows the number of charging cycles to be adjusted where equalization is not active.

Equalization at set intervals {1284}

In the event of usage with few charge cycles, it may be necessary to carry out equalization cycles at set intervals and not with a number of set cycles. If this configuration is activated, a new battery charge cycle with an activated equalization phase with the programmed interval is started {1285}.

Weeks between equalizations {1285}

Use this configuration to determine the time intervals that separate the battery charge cycles with active equalization phases.



Should incomplete charge cycles occur (for example, when charging by using solar generators), this function is also useful in order to limit the frequency of equalization cycles.

End of equalization activated by the current {1168}

The equalization phase can be interrupted if the charge current of the battery goes under a certain threshold. This can be used to limit the operating period of a genset while keeping an acceptable battery charge.



During the equalization phase, the charge current decreases progressively in a natural way. If the bulk charge has been achieved with a current suitable for the battery, it is not necessary to respect a fixed period to complete the charge.

End of equalization current {1169}

Set the current under which the equalization phase will be considered as completed. When the charge current goes under this value the next phase starts.

Reduced floating phase {1453}

In case the batteries are in low demand, the reduced floating phase may be activated. This phase makes it possible to reduce water consumption. In any case, respect the charge curve supplied by your battery manufacturer.

- A: Absorption phase
- B: Floating phase
- C: Duration before reduced floating phase
- D: Reduced floating voltage

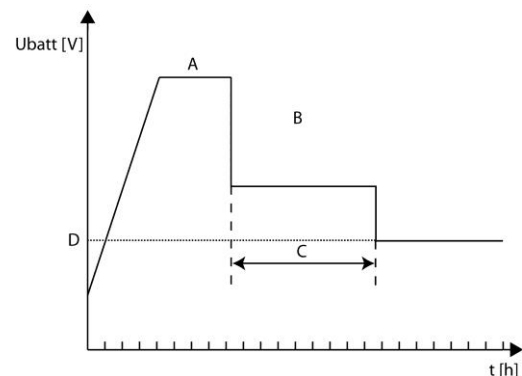

Authorized reduced floating phase {1170}

Allows you to authorize the reduced floating phase.

Duration of floating before reduced floating {1171}

The reduced floating phase begins after the floating phase. This setting allows you to fix the duration of the floating phase which precedes the reduced floating phase.

Voltage of reduced floating {1172}

Allows you to fix the battery voltage for the reduced floating phase.

Periodic absorption phase {1454}

The floating and reduced floating phases cause the stratification of the acid and the water in the batteries. The periodic absorption phase allows you to counter this problem.

- A: Duration of reduced floating before periodic absorption {1175}
- B: Periodic absorption voltage {1174}
- C: Duration of periodic absorption {1176}

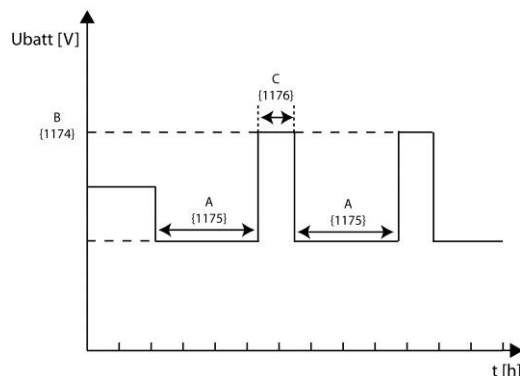

Authorized periodic absorption {1173}

Allows you to authorize the periodic absorption phase.

Periodic absorption voltage {1174}

Allows you to fix the battery voltage for the periodic absorption phase.

Duration of reduced floating before periodic absorption {1175}

The periodic absorption phase begins after the reduced floating phase. This setting allows you to fix the duration of the reduced floating phase which precedes the periodic absorption phase.

Duration of periodic absorption {1176}

This setting fixes the duration of the periodic absorption. Once this duration has elapsed, the battery returns to the reduced floating phase.

INVERTER {1186}

To set the different parameters of the function inverter, use this menu.

Authorized inverter {1124}

This configuration authorizes operation in inverter mode. If the inverter is deactivated, a voltage will be present on the output terminals (AC OUT) only if a correct voltage is present at the input (AC-in) and the transfer is not prohibited.

	This function can be used for supplying non-critical consumers while ensuring that the battery is not discharged even if the source is faulty.
--	--

	Note, that if the Smart-Boost function is activated, it is possible to discharge the battery even if the inverter function is locked.
--	---

Where there is lock on the inverter, charger or transfer function, a small padlock is displayed on the configuration display.

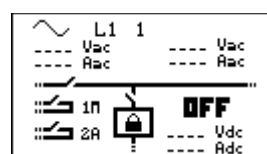

Output voltage {1286}

The output voltage can be adjusted using this configuration.

	<p>In certain fields of application – for example, when the energy source is limited (solar or generator only) – it may be useful to reduce the output voltage of the inverter. This generally leads to a resulting reduction in the energetic consumption without significantly decreasing comfort. For example, a 100 W light bulb consumes around 100W to 220V and 15% more at 230V.</p>
--	---

Increase of the linear AC-Out voltage with the battery voltage {1548}

This parameter enables you to set that the output voltage is influenced by the batteries voltage. The function depends on the batteries charge cycle and uses the reference voltage of the running cycle.

For instance: if the battery is carrying out an absorption, the output voltage will be modified close to this setting value. If the battery is in floating phase, the output voltage will be modified close to this setting value.

Maximum increase of the AC-Out voltage by the battery voltage {1560}

This parameter allows you to set the maximum increase of the AC-Out voltage if the previous function is activated.

- A : {1560}
- B : Reference of the battery cycle
- C : 0.5V for 12V
1V for 24V
2V for 48V

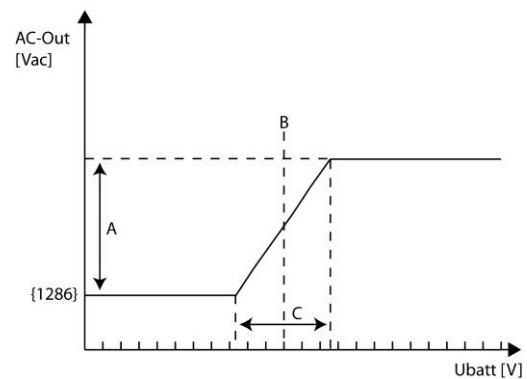

	<p>The main application of this function is the active loads control. It exists on the market voltage regulated loads that allow the intelligent consumption of the energy in excess (dump loads).</p>
--	--

	<p>We recommend to use an initial voltage of 220 Vac and not 230 Vac {1286} This allows to avoid a too high output voltage (for instance 240 Vac) when the function is active.</p>
--	--

Frequency {1112}

This setting allows you to alter the output frequency of the inverter of the WPC. This setting changes the limit frequencies on the charger's synchronization.

	<p>If you change the frequency from 50 to 60 Hz, the standard synchronization frequencies change from 45-65 to 55-75 Hz {1505}{1506}.</p>
--	---

Increase of the frequency at full battery {1536}

This function allows you to increase the inverter frequency when the battery is fully charged. The frequency variation is being carried out by index and non linear (frequency shift).

A : Reference of the battery cycle
 B : Floating voltage {1140}
 C : 0.5V for 12V
 1V for 24V
 2V for 48V

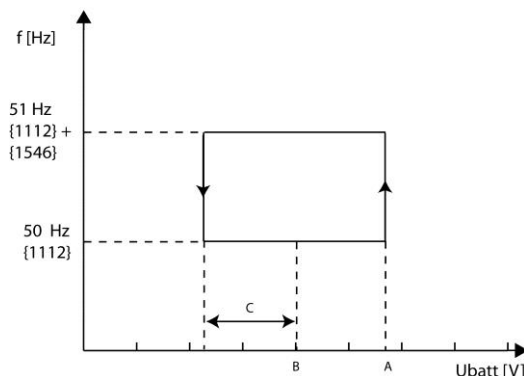

If you use this parameter with parameter {1549}, you will have the two corrections stacked over one another.



The main application of this parameter is "grid feeding". This function is not accounted for in this manual.

Frequency increase with the battery voltage {1549}

If you activate this parameter, the output frequency in inverter mode will vary in proportion to the battery voltage. The function is depending on the batteries charge cycle and uses the reference voltage of the current cycle.

The basic frequency is increased up to the maximum value of parameter {1546}.

A : Maximum increase of the frequency {1546}
 B : Battery cycle voltage reference
 C : 0.5V for 12V
 1V for 24V
 2V for 48V

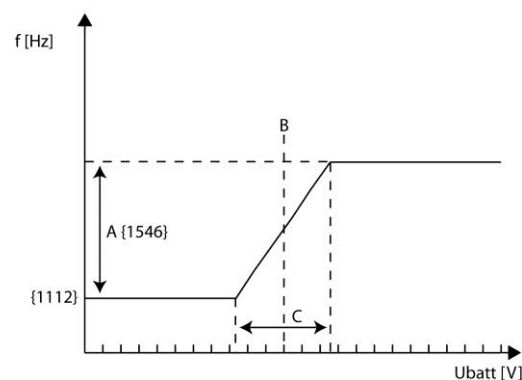

For instance if the battery carries out an absorption, the output frequency will be modified around this setting value. If the battery is in floating phase, the output frequency will be modified around this setting value.



If you use this parameter with parameter {1536}, you will have the two corrections stacked over one another.

Maximum increase of the frequency {1546}

This parameter determines how much the basic frequency is increased when a frequency variation is wished.

Standby and start (load detection) {1420}

Standby level {1187}

The standby function allows energy to be saved if there is no consumer present at the inverter output. In this case, the inverter disconnects its output and periodically emits a load search pulse. If a consumer is detected, it goes back into operational mode while measuring the power supplied and returns to standby if the consumer is deactivated.

This configuration allows adjustment of the power output at which the inverter goes into standby mode.

Proceed as follows to adjust this configuration:

Make sure that the inverter mode is active (no voltage present at the AC In input). The input voltage is 0 and the input relay is indicated as open in real time on the information screen.

Increase the standby level value {1187} to the maximum

Activate the smallest consumer that can be detected and ensure that all the others are deactivated.

Wait for the inverter to pass to standby, and the consumer then engages intermittently around once a second.

Progressively reduce the standby level value {1187} until the consumer runs permanently. If the consumer works for several seconds then stops, decrease the value of the standby level again.

An adjustment value between 0 and 100 is displayed. The value 100 represents the minimum sensitivity (biggest consumer detected).



If you would like to deactivate the standby function, it is sufficient to adjust the detection level to 0. In this case, the WPC remains permanently activated if it is working in inverter mode.

Duration between the standby pulses {1189}

This setting allows you to determine the interval between the standby pulses.

Number of standby periods {1188}

This setting determines the number of periods which are generated at the time of the standby burst.



Certain loads which are very difficult to detect may activate the inverter if the burst is longer than the only period normally used.

In certain very particular cases, the standby is used to supply very small consumers. Prolonging the search burst allows you to correctly supply these consumers without the risk of losing the supply during the waiting period between the pulses.

Duration of Soft start {1599}

Once the inverter is switched on the output voltage is progressively raised. This parameter sets the duration that is necessary to reach the nominal voltage.

Solsafe presence {1438}

Related to "grid feeding" and out of the scope of this manual.

AC-IN AND TRANSFER {1197}

These configurations manage the combined functions between the charger and inverter. The conditions for passing from one function to another are adjusted in this category.

- A. Stoppage of charger operation {1309}
- B. Disconnection of transfer subject to delay {1199}
- C. Delay before opening of the transfer {1198}
- D. Immediate passage to the inverter threshold {1200}

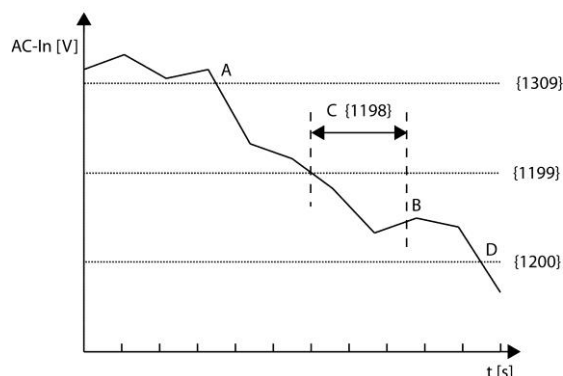

Transfer relay allowed {1128}

The transfer relay is authorized or not. If the transfer is not authorized, a correct voltage at the AC IN input will not be transferred to the output and to the users. The battery charger function is not possible and the WPC operates only in inverter mode.

Where there is lock on the inverter, charger or transfer function, a small padlock is displayed on the configuration display.

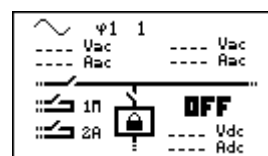

Delay before closing of the transfer relay {1580}

This parameter enables to delay the closing of the transfer relay even if the AC-In voltage is present.

i

This function can be useful while working with gensets having a pre-warming delay.

Maximum current of the AC source (Input limit) {1107}

Adjust this configuration in the event of connection to a limited power source, for example, a generator of moderate power output or a dock or camping connection. The adjustment of this value limits the instantaneous power consumed from the source in charger mode. The power available is attributed by first priority to consumers and then to battery charging. If the consumption level changes, the battery charge current is automatically adjusted.

- A. Power available and used to recharge the batteries
- B. Maximum AC source current (adjusted to 10 A here)
- C. Consumer current
- D. Power supplied by the inverter (Smart-Boost function)

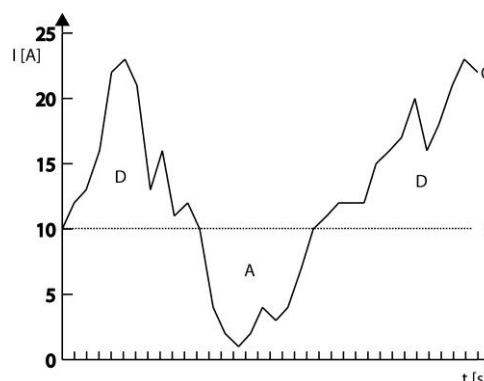

i

If the consumption level is higher than the controlled level, the maximum source current will be exceeded, except when the Smart-Boost function is activated.



It's possible to access faster to this function, please refer to the page 17

Smart-Boost authorized {1126}

The function Smart-Boost is deactivated by default. In this case no assistance will be provided to the source and if the source is overloaded, the energy from the battery is not drawn. Do authorize this function if you have a low power source (generator, shore power or camping plug) and you want more power available.



When the smart boost function is active, it is possible to discharge the batteries, even if the WPC is connected to a source and the charger is active.

Overrun AC source current limit without opening the transfer relay (Input limit) {1436}

The parameter {1107} allows you to adapt the running of the WPC to the maximum power of the source. In case this value is overrun, the transfer relay is not open and the circuit breaker on the source side may go on default. With this parameter you can force the transfer relay to open itself and the WPC to work in inverter mode.



Use this function if you have available a source that is smaller than the WPC and if you don't use the function Smart-Boost. In this way, in case of overload of the source, all the power is supplied by the WPC, up to its own limits.

Activate immediate detection of grid outage (UPS) {1435}

This parameter allows to starting the inverter mode as quick as possible in case of fluctuations of the AC-In grid. This function is useful when it comes to very sensitive loads that require an uninterruptible power supply (UPS). If this function is active, being connected to a fluctuating source (weak grid or unstable generator) will lead to a frequent switching between inverter and charger modes by opening and closing of the transfer relay.

Type of detection of AC input loss (UPS) {1552}

With this parameter it is possible to set the sensitivity at the WPC input (ACin) such that it can tolerate large fluctuation in the AC input voltage (setting Slow), moderate fluctuation (setting Tolerant) or act as a UPS (setting Fast).

Tolerance on the immediate detection of a grid loss (tolerant UPS mode) {1510}

With this parameter it is possible to set the sensitivity to detecting microcuts at the WPC input (ACin). Setting from 1 to 100 (by default: 100). A sensitivity of 60 means that the transfer opens by a cut equal or higher than 5ms, whereas a setting on 1 will lead the transfer to open from a cut of 80us.

Transfer AC-In for delayed transfer opening {1199}

This configuration determines the voltage below which the transfer relay will open after a certain period of time. The WPC will then run in inverter mode.

Delay before passing to inverter {1198}

When the input voltage is below the transfer voltage to the inverter, the transfer relay does not open immediately. With this configuration, the period during which the transfer remains drawn can be specified. After this duration, the transfer relay is opened and the inverter function is activated (if the function has not been blocked or deactivated).



This delay is particularly useful on less stable grids or with generators with an output voltage that varies considerably during the activation of heavy loads.

Immediate transfer AC-In voltage {1200}

Use the adjustment of this configuration to adjust the critical voltage for the operation of equipment that must not experience interruptions. In the case of a fluctuating grid, if its voltage passes below the value of the configuration this immediately activates the inverter function, thereby ensuring supply to the consumers.

INSTALLER – Absolute maximum input voltage {1432}

This parameter is set to define the max. threshold of the input voltage AC-In. In case of an input voltage higher than this threshold during 1 period (20 ms at 50 Hz), the transfer relay will be open.

Max input current modification {1471}

This setting allows you to adjust the value of the charge current of the batteries and the AC input current as a function of various external parameters.

Use an alternate max input current {1566}

If this parameter is activated, the value set for the max current of the source is reversed with the value programmed by the parameter below.

Second maximum current of AC source {1567}

Value used instead of the main value when the control entry is activated.



Use this function if you connect regularly two different sources like a genset and shore power. By using this function, you can go from one input limit to another without having to program the maximum value at each change of source.

Decrease max input limit current with AC-in voltage {1527}

This parameter forces the adaptation of the max. current of the source to the AC-in voltage.



If the voltage goes down, for instance with a genset, the parameter that determines the input max. current is adapted likewise. In this way not only the battery charge current is adapted but also the WPC power assistance if the function Smart-Boost is activated.

Decrease max input limit activated by remote entry {1554}

This parameter forces the adaptation of the max. current of the source to the AC-in voltage, ONLY when the remote contact is activated. See also parameter {1527}.

AC input low limit voltage to allow charger function {1309}

In the event of sources with limited power output (such as a generator, for example) the use of strong consumers at the output may lead to a drop in voltage. The adjustment of this configuration allows disconnection of the battery charging function and thus maintains the power available to other consumers without influencing the voltage of the source.

Adaptation range of the input current according to the input voltage {1433}

While the input voltage decreases, the charge current of the batteries is automatically lowered to avoid overloading the source. This parameter allows you to determine the voltage range over which this adaptation of the charge current of the batteries is carried out.

Speed of input limit increase {1553}

This parameter regulates the time it takes to increase the input limit again when it was decreased due to low AC input voltage (see parameter {1527}). It can be used to adjust the behaviour of an AC source such as a variable speed generator and can prevent different regulating and governing systems to oscillate.

Charge current decrease coefficient at voltage limit to turn back in inverter mode {1295}

When the AC-In input voltage decreases, the charge current of the batteries is automatically diminished accordingly. With this parameter, you determine the decrease coefficient of the charger current at charger shunt off threshold.

- A: Minimum voltage to allow the charger {1309}
- B: Start of charge current reduction = Disconnection of charger {1309} + {1433}
- C: Current reduction factor {1295}

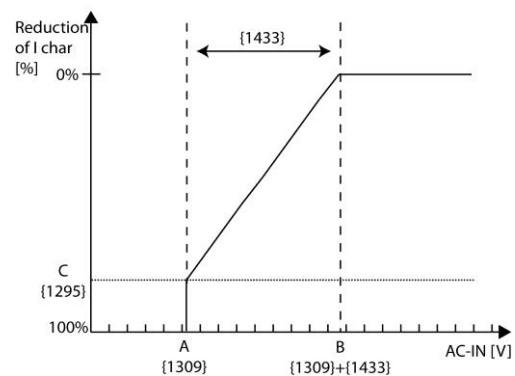

This setting is particularly useful when running a generator, as it allows you to adapt the charge current of the batteries to the fluctuations of the generator voltage without overloading it.

Frequency delta accepted above End {1505}

This setting allows you to determine the upper limit of the accepted frequency. This value is added to parameter {1112}, the output frequency of the inverter. If the frequency of the source exceeds this value, the transfer relay is opened after the duration determined by the setting {1507}.

Frequency delta accepted below End {1506}

This setting allows you to determine the lower limit of the accepted frequency. This value is subtracted from parameter {1112}, the output frequency of the inverter. If the frequency of the source is lower than this value, the transfer relay is opened after the duration determined by this setting {1507}.

Duration of erroneous frequency before disconnecting the transfer relay {1507}

If the input frequency is not included among the values determined by the settings above, the transfer relay is deactivated after the duration determined by this setting.

AC-In current active filtering {1575}

When this parameter is activated, the current taken on AC-Input is a sinusoid in phase with voltage. That mean only active power is taken from the generator. The inverter compensate harmonics and reactive current from the source.

This function also avoid fast speed change on the generator due to loads jumps.



For the filtering to work, it is also necessary to activate the Smart-Boost function {1126} and to authorize the charger {1231} {1339}.

CONFIGURATION FOR AUTOSTART AND GRID/GEN AC OUTPUT; AUXILIARY CONTACTS 1 AND 2 {1201} AND {1310}

The Autostart contact is controlled by and referred to as auxiliary contact 1 {1201}

The GRID/GEN AC output contact is controlled by and referred to as auxiliary contact 2 {1310}

The programming of each output is carried out independently. The auxiliary contacts are activated immediately in response to the programmed signals. When the activation conditions are no longer fulfilled, they are deactivated with a delay of 2 seconds to avoid overswitching.

The auxiliary contacts respond to various signal types presented graphically below.

The following types of basic events may activate the contacts:

- Simple event
- Scheduled event
- Level

In the following description, each parameter has two reference numbers. The reference on the left relates to auxiliary contact 1 and the reference on the right to auxiliary contact 2 ({reference of the auxiliary contact 1} {reference of the auxiliary contact2}).

i The auxiliary contacts are factory set with pre-defined functions. If you wish to implement a specific function you must clear the programming already set. Use for that purpose the parameter {1569} or {1570}.

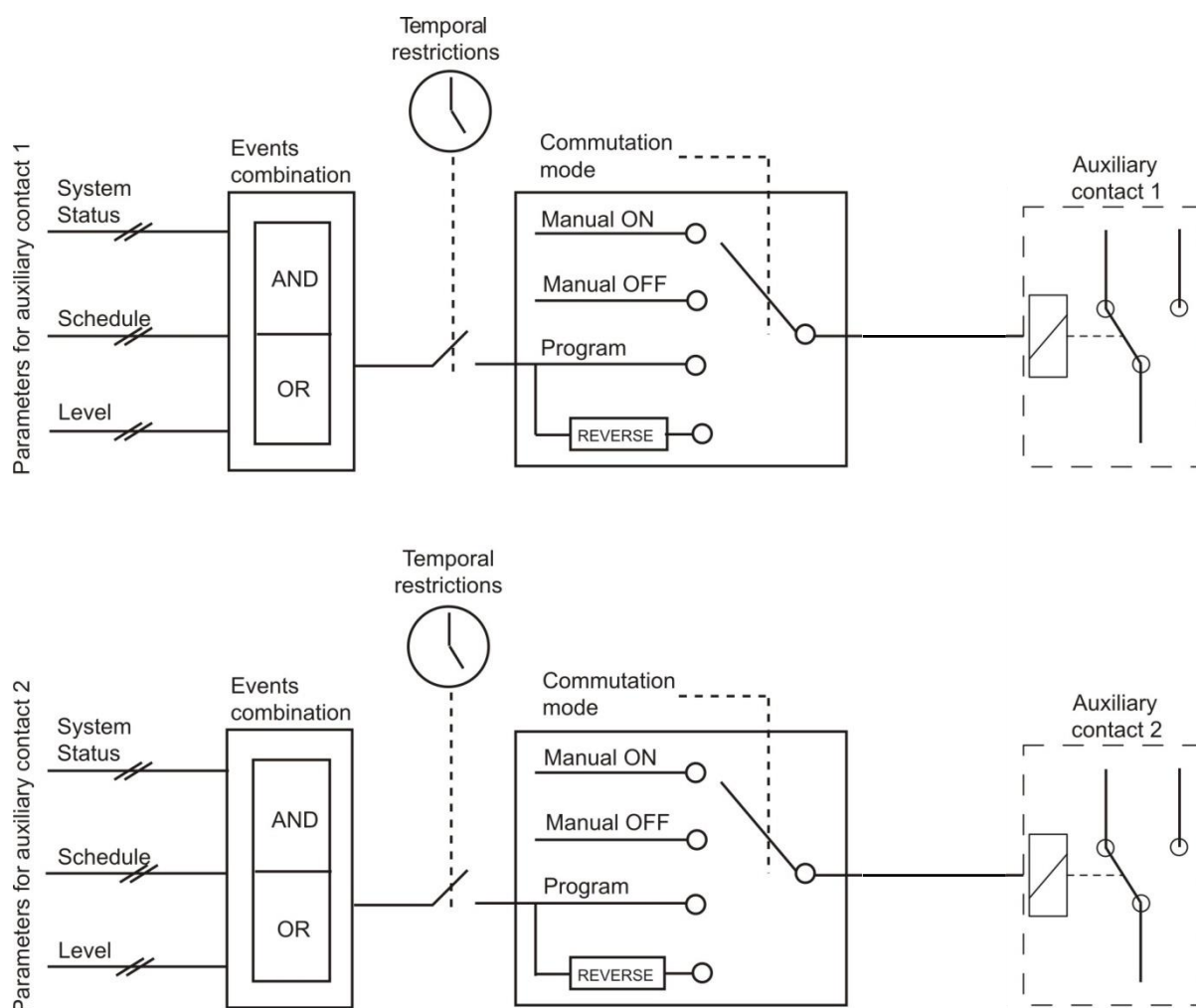



Simple functions

Switching mode {1202} {1311}

The auxiliary contacts may be controlled in 4 different ways:

Manual ON: In this mode, the contact is permanently drawn whatever the external conditions or programming

Manual OFF: In this mode, the contact is permanently released whatever the external conditions or programming

Automatic: In this mode, the auxiliary contact is activated according to the conditions and restrictions of its programming.

Reversed automatic: In this mode, the conditions and restrictions define the release of the contact.

Temporal restrictions {1203} {1312}

These configurations allow the time frame to be defined in which the contact should under no circumstances be activated. Three distinct schedules are accessible in the form of restriction programs (programs 1 to 3). For each program, it is possible to select the day of the week where the restriction is activated. If the day is selected it appears on the screen and if it is not selected it is represented on the screen by two horizontal lines.

Once the days are selected, it is necessary to adjust the time frame where the restriction is active using the "starting time" and "finishing time" configurations. If the finishing time is programmed before the starting time, the restriction time frame is not taken into account. Below are the configurations with their references:

Program 1 {1204} {1313}

Days of the week {1205} {1314}

Starting time {1206} {1315}

Finishing time {1207} {1316}

Program 2 {1208} {1317}

Days of the week {1209} {1318}

Starting time {1210} {1319}

Finishing time {1211} {1320}

Program 3 {1212} {1321}

Days of the week {1213} {1322}

Starting time {1214} {1323}

Finishing time {1215} {1324}

INSTALLER - Program 4 {1216} {1325}

Days of the week {1217} {1326}

Starting time {1218} {1327}

Finishing time {1219} {1328}

Program 5 {1220} {1329}

Days of the week {1221} {1330}

Starting time {1222} {1331}

Finishing time {1223} {1332}



If your installer has made additional adjustments, it is possible that the restrictions could be active even if they do not appear in one of the three programs available to you.

Contacts activated with set schedules {1269} {1378}

The auxiliary contact can also be activated like a programmable clock. Three different weekly programs are available.

For each program, the time frame may be applied to one or several days of the week.

If the finishing time is programmed before the starting time, the time frame is not taken into account.

Program 1 {1270} {1379}

Days of the week {1271} {1380}



Time of start of activation {1272} {1381}

Time of end of activation {1273} {1382}

Program 2 {1274} {1383}

Days of the week {1275} {1384}

Time of start of activation {1276} {1385}

Time of end of activation {1277} {1386}

Program 3 {1278} {1387}

Days of the week {1279} {1388}

Time of start of activation {1280} {1389}

Time of end of activation {1281} {1390}

Contacts activated by an event {1455} {1456}

The auxiliary contacts may be activated by the states or events occurring in the installation. Each event may be combined with another to establish complex functions.

WPC OFF {1225} {1333}

The contact is activated if the WPC inverter/charger is switched off, either following a fault or manually.

WPC ON {1518} {1519}

The auxiliary contact is activated if the WPC inverter/charger is switched on.

Remote ON/OFF input active {1543} {1544}

The auxiliary contact is activated if the Remote ON/OFF input is active.

Battery under voltage alarm {1226} {1334}

If the under voltage threshold is reached, this activates the contact. In contrast to the acoustic alarm that is deactivated after a set time, this signal remains active as long as the battery voltage is below the threshold. If the under voltage fault cuts in, this condition remains active as does the contact.

Battery overvoltage {1227} {1335}

Activates the contact in the event of battery overvoltage.

Inverter or smart boost overload {1228} {1336}

Activates the contact in the event of an error due to excessive power in the inverter or the Smart Boost function. In the event that the inverter disconnects due to excess power and it is attempting to restart, the contact is not activated until the end of the attempts.

Over temperature {1229} {1337}

Activates the contact in the event of over temperature in the electronics or the transformer.

No over temperature alarm {1520} {1521}

Activates the auxiliary contact if no over temperature alarm is active.

Active charger {1231} {1339}

Activates the auxiliary contact if the charger function is active. When the Smart-Boost function is operating, the condition for activating the contact is not fulfilled.

**Active inverter {1232} {1340}**

Activates the auxiliary contact if the inverter function is active.

Smart-Boost active {1233} {1341}

Activates the auxiliary contact if the Smart-Boost function is active. For more information on the smart boost function, refer to the manual for the WPC inverter/charger.

AC In present with fault {1234} {1342}

Activates the auxiliary contact if there is voltage present at the AC In input but this voltage does not fulfil the conditions for activating the transfer relay.

AC In present {1235} {1343}

Activates the auxiliary contact if a voltage is present at the AC In input. This condition is independent of the state of the transfer relay.

Transfer relay drawn {1236} {1344}

Activates the auxiliary contact if the transfer relay is drawn.

AC Out present {1237} {1345}

Activates the auxiliary contact if a voltage is present at the output of the WPC inverter/charger.

Battery charging in bulk charge phase {1238} {1346}

Activate the auxiliary contact if the battery is in bulk charge phase.

Battery charging in absorption phase {1239} {1347}

Activates the auxiliary contact if the battery is in absorption phase. If the periodic extended absorption function is activated, the contact is also activated in this phase.

Battery charging in equalization phase {1240} {1348}

Activates the auxiliary contact if the battery is in equalization phase.

Battery charging in floating phase {1242} {1350}

Activates the auxiliary contact if the battery is in maintenance phase. If the extended reduced floating function is activated, the contact is also activated in this phase.

Battery charging in reduced floating phase {1243} {1351} and**Battery charging in periodic absorption phase {1244} {1352}**

You can activate the auxiliary contacts on the reduced floating phase and the periodic absorption phase.

Autonomy test in progress {1529} {1530}

This parameter allows you to activate the auxiliary relays if an autonomy test is in progress. In that case, the relays are activated on the two types of test : monthly or weekly.

Contacts activated by the battery voltage {1245} {1353}

These configurations allow activation of the auxiliary contacts if the battery voltage passes below a selected voltage during a period that is configurable as well. Three voltages linked to three durations are configurable to activate the auxiliary contact.

The auxiliary contact will only be activated after the battery exceeds again a certain voltage value and also after a duration, both independently of the activation parameters.

This voltage and this duration are programmable too.

- Dynamic compensation of the thresholds {1288} {1354}
- Voltage 1 active {1246} {1355}
- Voltage 1 {1247} {1356}
- Duration 1 {1248} {1357}
- Voltage 2 active {1249} {1358}
- Voltage 2 {1250} {1359}
- Duration 2 {1251} {1360}
- Voltage 3 active {1252} {1361}
- Voltage 3 {1253} {1362}
- Duration 3 {1254} {1363}
- Voltage for deactivation of the auxiliary contact {1255} {1364}
- Duration over battery voltage for deactivation {1256} {1365}
- Deactivate if the battery is in floating mode {1516} {1517}

Dynamic compensation of the thresholds {1288} {1354}

If the contacts are activated according to the battery voltage, you can use the voltage dynamically compensated for each threshold.

If this function is not activated, the average battery voltage will be used.

If this function is activated, the real battery voltage is compensated according to the power used.

Deactivate if the battery is in floating mode {1516} {1517}

If you activate one of the auxiliary contacts according to the battery voltage, you can force the deactivation if the battery is in floating mode. In this way, even if the deactivation voltage is not reached or if the duration of the voltage deactivation is not completed, the auxiliary contact will be released.

Contacts activated by inverter power or Smart-Boost

{1257} {1366}

If the power output of the inverter exceeds a certain level, the contact may be activated. The excess is linked to a duration. Three power levels linked to three durations are configurable to activate the auxiliary contact.

The auxiliary contact will only be deactivated after the output power passes below a value and over a duration, both independently of the activation configurations.

If the Smart-Boost function is active, these configurations are also taken into account with the power of the boost.

- Power 1 active {1258} {1367}
- Power 1 {1259} {1368}
- Duration 1 {1260} {1369}
- Power 2 active {1261} {1370}
- Power 2 {1262} {1371}
- Duration 2 {1263} {1372}
- Power 3 active {1264} {1373}
- Power 3 {1265} {1374}
- Duration 3 {1266} {1375}
- Power for deactivation of the auxiliary contact {1267} {1376}
- Duration below power for deactivation {1268} {1377}

Contacts activated according to the battery temperature {1503} {1504}

You can activate an auxiliary contact according to the battery temperature. This function is available with the temperature sensor BTS-01 or with the battery monitor BSP. Two distinct thresholds allow a switch on and off of the contact at different temperatures.

- Contact active with the battery temperature {1446} {1457}
- Auxiliary contact activated below {1447} {1458}
- Auxiliary contact deactivated below {1448} {1459}

Contacts activated on battery state of charge (SOC) {1501} {1502} (function active only with a BSP)

You can activate the auxiliary contacts according to the battery state of charge. If the battery state of charge goes below a given threshold, the contact will be activated. A duration can be linked to the threshold, which means that the battery state of charge must be below this threshold within the chosen duration, before the contact is activated.

The contact is deactivated when the battery state of charge goes again below a specific threshold that can be also linked to a duration.

The contact can also be deactivated when the battery reaches the floating phase.

- Level SOC 1 active {1439} {1442}
- Level SOC 1 {1440} {1443}
- Duration 1 {1581} {1590}
- Level SOC 2 active {1582} {1591}
- Level SOC 2 {1583} {1592}
- Duration 2 {1584} {1593}
- Level SOC 3 active {1585} {1594}
- Level SOC 3 {1586} {1595}
- Duration 3 {1587} {1596}
- Level SOC to deactivate the auxiliary contact {1441} {1444}
- Duration on level for deactivation {1588} {1597}
- Deactivate if the battery is in floating phase {1589} {1598}

Security : Limit the time of activation {1512} {1513}



Caution :

If the maximum duration for the relay activation that you have selected is reached and if the activation conditions are still present (for instance a battery undervoltage), **the contact will not be reactivated as long as the conditions are present.** Therefore there is a risk that the auxiliary contact remains locked in this deactivated state and you will have to reset manually this alarm by deactivating and then activating this parameter.

Use this function with care and only as a security.

Maximum duration of activation {1514} {1515}

When the conditions are met, either one or two relays are activated permanently. If you wish that the activation duration is limited in time, even if the conditions are met, you can activate this function. Once the relay is activated, a countdown runs according to the duration you have selected. Once this countdown is completed the relay is released, even if the conditions are still there. The relay can not be anymore activated as long as the activation conditions have not disappeared.

SYSTEM {1101}

Command entry {1537}

The following parameters allow to customize the command entry.

Command entry active {1545}

This parameter allows you to determine if the command entry is activated closed or open.

Prohibits transfer relay {1538}

If this parameter is activated, the command entry forbids the closing of the transfer relay.

Inverter prohibited {1539}

If this parameter is activated, the command entry forbids the inverter function.

Charger prohibited {1540}

If this parameter is activated, the command entry forbids the battery charger function.

Smart Boost prohibited {1541}

If this parameter is activated, the command entry forbids the Smart-Boost function.

Forbids grid-feeding {1542}

This parameter forbids the grid-feeding by means of the command entry.

Command ON/OFF {1576}

When this parameter is active, a pulse on the function input enables to put the WPC ON or OFF. The max. duration of the pulse is 200ms.

Activated by the state AUX1 {1578}

This parameter enables to put the auxiliary contact status back on the command entry. It is then possible, without cable, to use the auxiliary contact conditions to activate the command entry.



Use for instance the programings of the auxiliary contact at fixed hour to alternatively forbid and authorize the charger according to the rate of the electricity from the grid.

Forbids the battery as priority source {1579}

If the battery was selected as priority energy source (see parameter {1296}), this priority can be cancelled with the function input and by activation of this parameter.

Reset all settings {1569} {1570}

This function serves to reset all previous settings done on the corresponding auxiliary contact. Once this operation done, the auxiliary contact is not activated anymore.

Caution: this function cannot be cancelled.



Use this function before programming any function for an auxiliary contact. By doing this way you are sure that you begin with no unexpected setting who can activate the contact.

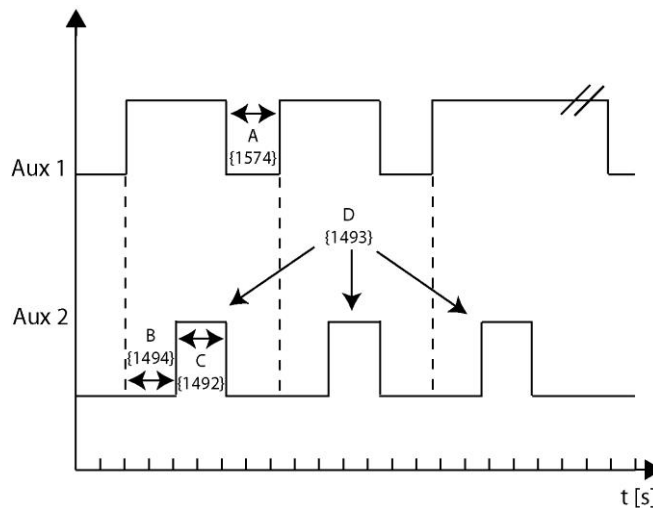

Battery as priority energy source {1296}

This parameter allows using in priority the energy stored in the battery even when an AC-In source is connected.



Use this function for instance if you are connected to an external source of renewable energy which you want to use in priority.

Voltage of the battery priority {1297}

When the function “battery as the priority energy source” is activated, the WPC will authorize the battery discharge until this voltage. Below this voltage the charger is put back on order to avoid a deeper discharge of the battery.

Duration of the acoustic alarm {1565}

The duration of the WPC acoustic alarm est defined with this parameter. The duration by default is 0min and then no acoustic warning will occur when an error message appears. If an acoustic warning is needed, this value must be set at least at 1min.

Automatic restart {1129}

In the event of an anomaly on the installation, the WPC stops automatically. Depending on the seriousness of the fault, when this disappears, the WPC may restart automatically without any user intervention (fault confirmation). The following functions allow the events for automatic restart to be defined.

After battery under voltage {1130}

Number of battery under voltages allowed before final stop {1304}

Lead-time to counting the battery under voltages allowed before final stop {1404}

Number of critical battery under voltages before final stop {1305}

Lead-time to counting the critical battery under voltages allowed before final stop {1405}

After battery overvoltage {1131}

After inverter or Smart-Boost overload {1132}

Delay to restart after an overload {1533}

After over temperature {1134}



Whatever the restart method, the event is recorded in the event history so that it can be called at any time.

Number of battery under voltages allowed before final stop {1304} and Leadtime to counting the battery under voltages allowed before final stop {1404}

If battery under voltage faults occur to your system, the inverter and Smart-Boost functions are deactivated in order to protect the battery against deep discharges.

These functions can be reactivated automatically if the fault disappears. With the parameter {1304}, you can adjust the number of the faults before these functions are definitely deactivated. In this case, an intervention is necessary to reactivate these functions (fault acknowledgement).

The duration parameter allows setting the time during which these faults can be repeated.

Once this duration has come to an end, if the number of faults is not reached, the counter goes back to 0 and the faults can occur again.



To cancel the automatic reactivation, set 1 for the number of battery under voltages allowed before final stop.
For a permanent automatically reactivation, set 0.

Number of critical battery under voltages before final stop {1305} and Leadtime to counting the critical battery under voltages allowed before final stop {1405}

The critical battery under voltages can also be automatically acknowledged in case of under voltage disappearance. Like for the under voltages (see previous paragraph) you can adjust the number of restarts of the inverter and Smart-Boost functions once the fault disappears.

Delay to restart after an overload {1533}

If the function inverter is stopped after an overload (power of the users too high) the inverter will do one or several attempts to restart. You can use this parameter to determine the time between the restart attempts (in seconds).



This gives you more time to disconnect the users which caused the overload.

Auto-start when switched on {1111}

When this setting is activated, the WPC starts itself automatically when the battery is connected.



Note that in this case, the output of the AC-Out is immediately supplied, and a lethal voltage is present on its terminals.

Ground/neutral system {1484}

This menu allows you to determine the switching rules for the neutral and its connection to the ground in transfer relay operation (inverter mode or charger mode).

Ground relay prohibited {1485}

If you activate this setting (yes), there will be no connection between the neutral and the ground, whatever the mode of operation (inverter or charger).

If this setting is deactivated (no), the neutral is connected to the ground during operation in inverter mode and disconnected in charger mode, i.e. when the transfer relay is closed and the AC-In is connected to the AC-Out.

Neutral always connected {1486}

If this setting is activated, the neutral of the AC-Out remains connected to the neutral of the AC-In when the WPC is operating in inverter mode.

Self-test of autonomy {1473}

In case of use in emergency systems, certain regulations impose a periodic test of the system's autonomy. You can automate this test by using the following menus. There are two tests available, a weekly test and a monthly one.

At the programmed time, the system simulates a lack of grid (AC-In) and opens the transfer relay to work in inverter mode. If after the programmed duration, there has not been a battery under voltage, a success message is displayed and memorized. Then the system reconnects the input to recharge the batteries. If an under voltage alarm occurs during the test duration, the system reconnects immediately the input to recharge the batteries and an error message is displayed and recorded.

The test is carried out without any interruption for the users.



Program these tests out of the critical hours (for instance during the night). This will allow the batteries to recharge even if a short power cut occurs right after the test.

Weekly test {1474}

These options allow you to set up a test which will take place every week.

Manual start of a weekly test {1495}

Allows you to immediately carry out a weekly test, without taking the predefined days into account.

Days of the week {1475}

You can carry out a test per day of the week if you wish. The days displayed are those on which the tests will be carried out.

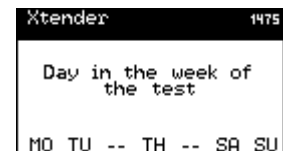

Time of test start {1476}, Duration of test {1477}

With these two settings you determine the time of the start and the duration of the weekly test. If this test is carried out several days of the week, these settings are identical for each day.

Monthly test {1478}

These options allow you to set up a test which will take place up to once a month.

Manual start of a monthly test {1496}

Allows you to immediately carry out a monthly test, without taking the predefined days into account.

Month of test {1479}

You may carry out up to one test per month using this setting. The months displayed (the first letter of the month only) represent the months in which the monthly test will be carried out.

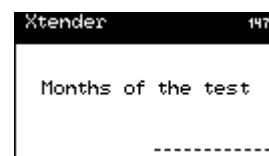

Date of the monthly test {1480}

You can choose the day on which the test will take place (from 1 to 31), if the day does not exist (e.g. February 31) the test will not be carried out.

Day of the week of the monthly test {1481}

You can also choose the day of the week (Monday to Sunday) on which the test will take place. If a day of the week is activated, the setting "Date of the monthly test {1480}" indicates the week of the test.

	For example: {1480} = 3 and {1481} = Tuesday, the test will take place on the third Tuesday of the month(s) selected in {1479}
---	---

Time of test start {1482}, Duration of test {1483}

With these two settings you determine the time of the start and the duration of the monthly test. If this test is carried out several months of the year, these settings are identical for each test.

INSTALLER – Flash saving of the parameter {1550}

This parameter allows you to determine if the parameters modified in your system must be saved or not. To save the lifetime of the flash memory in case of repeated writings, this parameter must, for instance, be deactivated (no). Like in the case of communication between your system and an external SCADA system.

Reset of all inverters {1468}

This parameter allows you to restart all inverters.

MULTI WPC {1282}

This section allows setting the operating possibilities of systems with several WPC's. Either parallel or 3-phase.

3-phase integral mode {1283}

If you activate this parameter, the system will work in order to have either a 3-phase output, or no output voltage. For instance in case of one phase overload, if the integral mode is activated, the cut of this phase will lead to the cut of all phases.

Multiple authorized inverters {1461}

This parameter allows to forbid the setting in parallel or in 3-phase of a system. If this parameter is deactivated and several WPC's are connected with the link cable, it will be impossible to put them on.

Multiple independent inverters {1462}

This setting allows you to use several WPC's connected via the same communication bus, without using synchronization. The phase selection tabs are therefore not in operation. However, in order to display the user information, the RCC remote control uses this information (if two inverters are programmed on the same phase, they appear as if they are in parallel on the remote control).

Authorize the stand-by of the secondary inverters (slaves) {1547}

When several WPC's are connected in parallel and the energy consumption is reduced, one single WPC may be enough to cope with the needs. In that case, the others can be put in stand-by in order to save energy. This parameter allows you to authorize or not the stand-by of the secondary WPC's.



As soon as the power reaches around 75% of the WPC nominal power the others are activated.
The activation time is around 50ms.

Split hase (dual phase) : L2 with 180 degrees phase displacement {1571}

Displaces the phase L2 by 180 degrees instead of standard three phase systems 120 degrees. L2 is in reverse phase compared to L1.



This is about an electrical configuration mainly used in North and Central America. It is meant to obtain 240V with two inverters in reverse phase, while keeping 120V on each phase.

GRID-FEEDING {1522} (Is out of the scoop of this manual)

INFORMATION ON THE SYSTEM

The system information allows you to check the versions of the various elements of your installation.

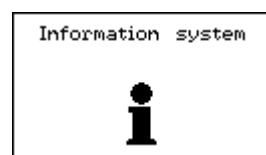

REMOTE CONTROLS

You will receive information on the hardware and software versions for each remote control. Furthermore, you have access to its unique ID number. This unique number is marked FID followed by its ID.

WPC

For each WPC connected at the remote control, you can consult the following information: the hardware version of the motherboard itself as well as the power board, the software version of the WPC program and the unique ID of the WPC. This unique number is also marked FID and followed by its ID.

SOFTWARE(S) UPDATING

The software of the remote control RCC/PSCP as well as the software built in inverter-chargers of the WPC range, the communication module RS-232 (Xcom-232i), the battery monitor (BSP) and the communication bridge MPPT (Xcom-MS) can be updated in order that they integrate all new functionalities.

For the remote control RCC/PSCP itself it is also possible to integrate new display languages (max. 4 in each RCC/PSCP). To know more about the updating or additional languages availability, contact your installer or go to www.whisperpower.nl.

UPDATING PROCESS



Before inserting the SD card to carry out an updating, it is better to switch off all WPC's (off). If you don't do it manually, the updating process will automatically stop all WPC's connected to the remote control.

To carry out an updating, insert the SD card (containing the last update) into the slot of the remote control. Before proceeding with the updating, the system checks automatically the compatibility between the material and the software present on the card. The SD card must not be removed until the updating process is completed. If however the updating process was interrupted, insert the SD card again to let the process carry on.

The updating process takes 3 to 15 minutes depending on the number of devices connected to the communication bus.

Once the updating is completed, the remote control displays one of the following messages:

- « Message (051) : The updating is completed »

or

- « Message (052) : Your installation is already updated »

or

- « Error (050) : Data transfer uncompleted »

In the last case, the updating process has not ended correctly. You must start it again from the beginning.

In the case of a change of language, the system restarts automatically with the new one as current language.



If the installation has several remote controls, each of them must be updated separately.

APPENDICES

APPENDIX 1 : LIST OF CONFIGURATION INTERDEPENDENCIES

N°	Configuration	N°	Minimum limit by	N°	Maximum limit by
{1108}	Under voltage of the empty battery	{1109}	Under voltage of the charged battery	{1110}	Reactivation voltage after battery undervoltage
{1109}	Under voltage of the charged battery			{1108}	Undervoltage of the empty battery
{1110}	Reactivation voltage after battery under voltage	{1108}	Under voltage of the empty battery		
{1121}	Maximum operating voltage	{1122}	Reactivation voltage after battery overvoltage		
{1122}	Reactivation voltage after battery overvoltage			{1121}	Maximum operating voltage
{1140}	Battery maintenance voltage (floating)			{1156}	Battery absorption voltage
{1156}	Battery absorption voltage	{1140}	Battery maintenance voltage (floating)		
{1164}	Battery equalization voltage	{1156}	Battery absorption voltage		
{1172}	Reduced maintenance voltage			{1140}	"Battery maintenance voltage (floating)"
{1174}	Periodic absorption voltage	{1172}	Reduced maintenance voltage		
{1195}	Adaptable maximum low voltage	{1108}	Undervoltage of the empty battery		
{1199}	Transfer voltage to the inverter	{1200}	Immediate open critical threshold for the transfer (UPS)		
{1200}	Immediate open critical threshold for the transfer (UPS)			{1199}	Transfer voltage to the inverter



PARAMETERS TABLE

REMOTE CONTROL PARAMETERS

Level	User ref.	Parameter	Unit	12			24			48			Modi. val
				Factory	Min	Max	Factory	Min	Max	Factory	Min	Max	
Basic	5000	Language	English	0	0	3	0	0	3	0	0	3	
Expert	5036	Other languages											
Basic	5038	Choice of the second language	Text	French	English	Italian	French	English	Italian	French	English	Italian	
Basic	5039	Choice of the third language	Text	German	English	Italian	German	English	Italian	German	English	Italian	
Basic	5040	Choice of the fourth language	Text	Spanish	English	Italian	Spanish	English	Italian	Spanish	English	Italian	
Basic	5001	Time		00:00	00:00	23:59	00:00	00:00	23:59	00:00	00:00	23:59	
Basic	5002	Date		0	0	0	0	0	0	0	0	0	
Basic	5003	Day		1	1	31	1	1	31	1	1	31	
Basic	5004	Month	Text	January	January	December	January	January	December	January	January	December	
Basic	5005	Year		2006	2006	2105	2006	2006	2105	2006	2006	2105	
V.O.	5012	User level		16	0	111	16	0	111	16	0	111	
Expert	5019	Force remote control to user BASIC level		S	S	S	S	S	S	S	S	S	
Expert	5057	Datalogger											
Expert	5058	Datalogger enabled	No/Yes	No	No	Yes	No	No	Yes	No	No	Yes	
Expert	5059	Save today's datas		S	S	S	S	S	S	S	S	S	
Basic	5013	Save and restore files											
Basic	5041	Save all files (system backup)		S	S	S	S	S	S	S	S	S	
Basic	5068	Restore all files (system recovery)		S	S	S	S	S	S	S	S	S	
Basic	5070	Apply configuration files (masterfile)		S	S	S	S	S	S	S	S	S	
Expert	5032	Separator of the .csv files	Text	Automatic	Automatic	,	Automatic	Automatic	,	Automatic	Automatic	,	
Expert	5069	Advanced backup functions											
Expert	5030	Save messages		S	S	S	S	S	S	S	S	S	
Expert	5049	Save and restore RCC files											
Expert	5015	Save RCC parameters		S	S	S	S	S	S	S	S	S	



PARAMETERS TABLE

Level	User ref.	Parameter	Unit	12			24			48			Modi. val
				Factory	Min	Max	Factory	Min	Max	Factory	Min	Max	
Expert	5016	Load RCC parameters		S	S	S	S	S	S	S	S		
Expert	5050	Save and restore WPC files											
Expert	5017	Save WPC parameters		S	S	S	S	S	S	S	S		
Expert	5018	Load WPC parameters		S	S	S	S	S	S	S	S		
Inst.	5033	Create WPC configuration file (masterfile)		S	S	S	S	S	S	S	S		
Expert	5034	Load WPC configuration file (masterfile)		S	S	S	S	S	S	S	S		
Expert	5045	Load WPC parameters preset	Choose	1	1	1	1	1	1	1	1		
Expert	5051	Save and restore BSP files											
Expert	5052	Save BSP parameters		S	S	S	S	S	S	S	S		
Expert	5053	Load BSP parameters		S	S	S	S	S	S	S	S		
Inst.	5054	Create BSP configuration file (masterfile)		S	S	S	S	S	S	S	S		
Expert	5055	Load BSP configuration file (masterfile)		S	S	S	S	S	S	S	S		
Inst.	5047	Format the SD card		S	S	S	S	S	S	S	S		
Expert	5061	Start update		S	S	S	S	S	S	S	S		
Inst.	5042	Modification of access levels of many parameters											
Inst.	5043	Change all parameters access level to:	Text	Choose	Choose	INSTALLER	Choose	Choose	INSTALLER	Choose	Choose	INSTALLER	
Inst.	5044	Restore default access level of all parameters		S	S	S	S	S	S	S	S		
Expert	5007	Backlight											
Expert	5008	Backlight always off	No/Yes	No	No	Yes	No	No	Yes	No	No	Yes	
Expert	5009	Backlight switch off after	sec	120	5	120	120	5	120	120	5	120	
Expert	5026	Red backlight flashing on WPC off and faulty	No/Yes	Yes	No	Yes	Yes	No	Yes	Yes	No	Yes	
Basic	5021	Extended and special functions											
Basic	5006	Display contrast	%	45	0	100	45	0	100	45	0	100	
Expert	5010	Come back to standard display after	sec	600	5	600	600	5	600	600	5	600	
Expert	5011	Visibility of the transitory messages	sec	60	5	180	60	5	180	60	5	180	
Basic	5027	Acoustic alarm active	No/Yes	Yes	No	Yes	Yes	No	Yes	Yes	No	Yes	
Expert	5031	Remote control acoustic alarm duration	sec	120	5	120	120	5	120	120	5	120	
Expert	5056	Switching ON and OFF of system on level "VIEW ONLY"	No/Yes	Yes	No	Yes	Yes	No	Yes	Yes	No	Yes	
Expert	5071	Reset of all the remotes control		S	S	S	S	S	S	S	S		
Inst.	5072	Activation of the old CAN protocol (v 1.1.x)	No/Yes	No	No	Yes	No	No	Yes	No	No	Yes	



WPC PARAMETERS

Level	User ref.	Parameter	Unit	12			24			48			Modi. val
				Factory	Min	Max	Factory	Min	Max	Factory	Min	Max	
Basic	1100	BASIC SETTINGS											
Basic	1107	Maximum current of AC source (Input limit)	Aac	32	2	50	32	2	50	32	2	50	
Basic	1138	Battery charge current	Adc	60	0	200	60	0	200	60	0	200	
Basic	1126	Smart-Boost allowed	Yes/No	No	Yes	No	No	Yes	No	No	Yes	No	
Basic	1124	Inverter allowed	Yes/No	Yes	Yes	No	Yes	Yes	No	Yes	Yes	No	
Expert	1510	Tolerance on detection of AC-input loss (UPS mode)		50	3	70	50	3	70	50	3	70	
Basic	1187	Standby level	%	10	0	100	10	0	100	10	0	100	
Basic	1395	Restore default settings		S	S	S	S	S	S	S	S	S	
Inst.	1287	Restore factory settings		S	S	S	S	S	S	S	S	S	
Expert	1137	BATTERY MANAGEMENT AND CYCLE											
Expert	1125	Charger allowed	Yes/No	Yes	Yes	No	Yes	Yes	No	Yes	Yes	No	
Basic	1138	Battery charge current	Adc	45	0	200	45	0	200	45	0	200	
Expert	1139	Battery temperature compensation	mV/°C/ce 	-4	-8	0	-4	-8	0	-4	-8	0	
Expert	1568	Undervoltage											
Expert	1108	Battery undervoltage level without load	Vdc	11.6	9.5	18	23.2	19	36	46.3	37.9	72	
Expert	1531	Battery undervoltage dynamic compensation											
Expert	1191	Battery undervoltage dynamic compensation	No/Yes	Yes	No	Yes	Yes	No	Yes	Yes	No	Yes	
Expert	1532	Kind of dynamic compensation	Text	Automatic	Manual	Automatic	Automatic	Manual	Automatic	Automatic	Manual	Automatic	
Expert	1109	Battery undervoltage level at full load	Vdc	10.5	9.5	18	21	19	36	42	37.9	72	
Expert	1190	Battery undervoltage duration before turn off	min	3	0	60	3	0	60	3	0	60	
Expert	1110	Restart voltage after batteries undervoltage	Vdc	12	9.5	18	24	19	36	48	37.9	72	
Expert	1196	Battery low level for acoustic alarm	Vdc	10.8	9.5	18	21.6	19	36	43.2	37.9	72	
Expert	1469	Acoustic alarm duration	min	3	0	10	3	0	10	3	0	10	
Expert	1194	Battery adaptive low voltage	No/Yes	No	No	Yes	No	No	Yes	No	No	Yes	
Expert	1195	Max voltage for adaptive low voltage	Vdc	12.5	10.2	12.6	25	20.4	25.2	49.9	40.8	50.4	
Expert	1307	Reset voltage for adaptive correction	Vdc	13.2	9.5	18	26.4	19	36	52.8	37.9	72	
Expert	1298	Increment step of the adaptive low voltage	Vdc	0.1	0	0.4	0.2	0	0.7	0.5	0	1.4	
Expert	1121	Battery overvoltage level	Vdc	17	9.5	18.6	34.1	19	37.2	68.2	37.9	74.4	
Expert	1122	Restart voltage level after an battery overvoltage	Vdc	16.2	9.5	18	32.4	19	36	64.8	37.9	72	



INVERTER PARAMETERS

Level	User ref.	Parameter	Unit	12			24			48			Modi. val
				Factory	Min	Max	Factory	Min	Max	Factory	Min	Max	
Expert	1140	Battery floating level	Vdc	13.6	9.5	18	27.2	19	36	54.5	37.9	72	
Expert	1467	Force phase of floating		S	S	S	S	S	S	S	S	S	
Expert	1141	New cycle menu											
Expert	1142	Force a new cycle		S	S	S	S	S	S	S	S	S	
Expert	1143	Battery voltage level 1 to start a new cycle	Vdc	12.5	9.5	18	25	19	36	49.9	37.9	72	
Expert	1144	Time period under battery voltage level 1 to start a new cycle	min	30	0	240	30	0	240	30	0	240	
Expert	1145	Battery voltage level 2 to start a new cycle	Vdc	12.3	9.5	18	24.6	19	36	49.2	37.9	72	
Expert	1146	Time period under battery voltage level 2 to start a new cycle	sec	60	0	600	60	0	600	60	0	600	
Expert	1149	New cycle priority on absorption and equalization phases	No/Yes	No	No	Yes	No	No	Yes	No	No	Yes	
Expert	1147	Battery cycling restricted	No/Yes	No	No	Yes	No	No	Yes	No	No	Yes	
Expert	1148	Minimal delay between cycles	hours	3	0	540	3	0	540	3	0	540	
Expert	1451	Phase of absorption											
Expert	1155	Absorption phase allowed	No/Yes	Yes	No	Yes	Yes	No	Yes	Yes	No	Yes	
Expert	1156	Battery absorption voltage	Vdc	14.4	9.5	18	28.8	19	36	57.6	37.9	72	
Expert	1157	Absorption duration	hours	2	.2	18	2	.2	18	2	.2	18	
Expert	1158	End of absorption triggered with current	No/Yes	Yes	No	Yes	Yes	No	Yes	Yes	No	Yes	
Expert	1159	Current limit to quit the absorption phase	Adc	10	4	200	10	4	200	10	4	200	
Expert	1160	Maximal frequency of absorption control	No/Yes	No	No	Yes	No	No	Yes	No	No	Yes	
Expert	1161	Minimal delay since last absorption	hours	2	0	540	2	0	540	2	0	540	
Expert	1452	Phase of equalization											
Expert	1163	Equalization allowed	No/Yes	No	No	Yes	No	No	Yes	No	No	Yes	
Expert	1162	Force equalization		S	S	S	S	S	S	S	S	S	
Expert	1291	Equalization before absorption phase	No/Yes	Yes	No	Yes	Yes	No	Yes	Yes	No	Yes	
Expert	1290	Equalization current	Adc	60	0	200	60	0	200	60	0	200	
Expert	1164	Equalization voltage	Vdc	15.6	13	18	31.2	26	36	62.4	52.1	72	
Expert	1165	Equalization duration	hours	.5	.2	10	.5	.2	10	.5	.2	10	
Expert	1166	Number of cycles before an equalization		25	0	100	25	0	100	25	0	100	
Expert	1284	Equalization at fixed interval	No/Yes	No	No	Yes	No	No	Yes	No	No	Yes	
Expert	1285	Weeks between equalizations	weeks	26	1	104	26	1	104	26	1	104	
Expert	1168	End of equalization triggered with current	No/Yes	No	No	Yes	No	No	Yes	No	No	Yes	
Expert	1169	Current limit to quit the equalization phase	Adc	4	4	30	4	4	30	4	4	30	
Expert	1453	Phase of reduced floating											
Expert	1170	Reduced floating allowed	No/Yes	No	No	Yes	No	No	Yes	No	No	Yes	
Expert	1171	Floating duration before reduced floating	days	1	0	31	1	0	31	1	0	31	



INVERTER PARAMETERS

Level	User ref.	Parameter	Unit	12			24			48			Modi. val
				Factory	Min	Max	Factory	Min	Max	Factory	Min	Max	
Expert	1172	Reduced floating voltage	Vdc	13.2	13	18	26.4	26	36	52.8	52.1	72	
Expert	1454	Phase of periodic absorption											
Expert	1173	Periodic absorption allowed	No/Yes	No	No	Yes	No	No	Yes	No	No	Yes	
Expert	1174	Periodic absorption voltage	Vdc	14.4	13	18	28.8	26	36	57.6	52.1	72	
Expert	1175	Reduced floating duration before periodic absorption	days	7	0	31	7	0	31	7	0	31	
Expert	1176	Periodic absorption duration	hours	.5	0	10	.5	0	10	.5	0	10	
Expert	1186	INVERTER											
Basic	1124	Inverter allowed	Yes/No	Yes	Yes	No	Yes	Yes	No	Yes	Yes	No	
Expert	1286	AC Output voltage	Vac	230	110	280	230	110	280	230	110	280	
Expert	1548	AC voltage increase according to battery voltage	No/Yes	No	No	Yes	No	No	Yes	No	No	Yes	
Expert	1560	Max AC voltage increase with battery voltage	Vac	10	5	15	10	5	15	10	5	15	
Expert	1112	Inverter frequency	Hz	50	45	65	50	45	65	50	45	65	
Expert	1536	Inverter frequency increase when battery full	No/Yes	No	No	Yes	No	No	Yes	No	No	Yes	
Expert	1549	Inverter frequency increase according to battery voltage	No/Yes	No	No	Yes	No	No	Yes	No	No	Yes	
Expert	1546	Max frequency increase	Hz	4	0	10	4	0	10	4	0	10	
Expert	1534	Speed of volt. or frequency change in function of battery		-2	-4	-2	-2	-4	-2	-2	-4	-2	
Expert	1420	Standby and turn on											
Basic	1187	Standby level	%	10	0	100	10	0	100	10	0	100	
Expert	1189	Time delay between standby pulses	sec	.8	.2	10	.8	.2	10	.8	.2	10	
Expert	1188	Standby number of pulses		1	1	10	1	1	10	1	1	10	
Expert	1599	Softstart duration	sec	0	0	1	0	0	1	0	0	1	
Expert	1438	Solsafe presence Energy source at AC-Out side	No/Yes	No	No	Yes	No	No	Yes	No	No	Yes	
QSP	1572	Modulator ru_soll	No/Yes	No	No	Yes	No	No	Yes	No	No	Yes	
Expert	1197	AC-IN AND TRANSFER											
Expert	1128	Transfer relay allowed	Yes/No	Yes	Yes	No	Yes	Yes	No	Yes	Yes	No	
Expert	1580	Delay before closing transfer relay	min	0	0	30	0	0	30	0	0	30	
Basic	1126	Smart-Boost allowed	Yes/No	No	Yes	No	No	Yes	No	No	Yes	No	
Basic	1107	Maximum current of AC source (Input limit)	Aac	16	2	50	16	2	50	16	2	50	
Basic	1471	Max input current modification											
Expert	1566	Use an alternate max input current	No/Yes	No	No	Yes	No	No	Yes	No	No	Yes	
Basic	1567	Second maximum current of AC source (Input limit)	Aac	13	2	50	13	2	50	13	2	50	
Expert	1527	Decrease max input limit current with AC-In voltage	No/Yes	No	No	Yes	No	No	Yes	No	No	Yes	
Expert	1554	Decrease max input limit activated by remote entry	No/Yes	Yes	No	Yes	Yes	No	Yes	Yes	No	Yes	
Expert	1309	AC input low limit voltage to allow charger function	Vac	220	100	230	220	100	230	220	100	230	



INVERTER PARAMETERS

Level	User ref.	Parameter	Unit	12			24			48			Modi. val
				Factory	Min	Max	Factory	Min	Max	Factory	Min	Max	
Expert	1433	Adaptation range of the charge current according to the input voltage	Vac	5	5	30	5	5	30	5	5	30	
Expert	1553	Speed of input limit increase	60	60	0	100	60	0	100	60	0	100	
Expert	1295	Charge current decrease coef. at voltage limit to turn back in inverter mode	%	100	0	100	100	0	100	100	0	100	
Expert	1436	Overrun AC source current limit without opening the transfer relay (Input limit)	No/Yes	Yes	No	Yes	Yes	No	Yes	Yes	No	Yes	
Basic	1552	Type of detection of AC input loss (UPS)		Tolerant	Slow	Fast	Tolerant	Slow	Fast	Tolerant	Slow	Fast	
Expert	1510	Tolerance on detection of AC-input loss (UPS mode)		100	3	100	100	3	100	100	3	100	
Expert	1199	Input voltage giving an opening of the transfer relay with delay	Vac	180	50	230	180	50	230	180	50	230	
Expert	1198	Time delay before opening of transfer relay	sec	8	0	30	8	0	30	8	0	30	
Expert	1200	Input voltage giving an immediate opening of the transfer relay (UPS)	Vac	110	50	230	110	50	230	110	50	230	
Inst.	1432	Absolute max limit for input voltage	Vac	250	235	290	250	235	290	250	235	290	
QSP	1500	Standby of the charger allowed	No/Yes	Yes	No	Yes	Yes	No	Yes	Yes	No	Yes	
Expert	1505	Delta frequency allowed above the standard input frequency	Hz	35	0	35	35	0	35	35	0	35	
Expert	1506	Delta frequency allowed under the standard input frequency	Hz	15	0	15	15	0	15	15	0	15	
Expert	1507	Duration with frequency error before opening the transfer	sec	5	1	5	5	1	5	5	1	5	
Expert	1575	AC-IN current active filtering	No/Yes	Yes	No	Yes	Yes	No	Yes	Yes	No	Yes	
Expert	1201	AUXILIARY CONTACT 1											
Expert	1202	Operating mode (AUX 1)	Text	Automatic	Automatic	Manual OFF	Automatic	Automatic	Manual OFF	Automatic	Automatic	Manual OFF	
Expert	1497	Combination of the events for the auxiliary contact (AUX 1)	Text	Any (Function OR)	Any (Function OR)	All (Function AND)	Any (Function OR)	Any (Function OR)	All (Function AND)	Any (Function OR)	Any (Function OR)	All (Function AND)	
Expert	1203	Temporal restrictions (AUX 1)											
Expert	1204	Program 1 (AUX 1)											
Expert	1205	Day of the week (AUX 1)	days	----- ---	----- -----	MO TU WE TH FR SA SU	----- ---	----- -----	MO TU WE TH FR SA SU	----- ---	----- -----	MO TU WE TH FR SA SU	
Expert	1206	Start hour (AUX 1)	hh:mm	07:00	00:00	23:59	07:00	00:00	23:59	07:00	00:00	23:59	
Expert	1207	End hour (AUX 1)	hh:mm	20:00	00:00	23:59	20:00	00:00	23:59	20:00	00:00	23:59	
Expert	1208	Program 2 (AUX 1)											
Expert	1209	Day of the week (AUX 1)	days	----- ---	----- -----	MO TU WE TH FR SA SU	----- ---	----- -----	MO TU WE TH FR SA SU	----- ---	----- -----	MO TU WE TH FR SA SU	
Expert	1210	Start hour (AUX 1)	hh:mm	07:00	00:00	23:59	07:00	00:00	23:59	07:00	00:00	23:59	
Expert	1211	End hour (AUX 1)	hh:mm	20:00	00:00	23:59	20:00	00:00	23:59	20:00	00:00	23:59	
Expert	1212	Program 3 (AUX 1)											



INVERTER PARAMETERS

Level	User ref.	Parameter	Unit	12			24			48			Modi. val
				Factory	Min	Max	Factory	Min	Max	Factory	Min	Max	
Expert	1213	Day of the week (AUX 1)	days	-----	-----	MO TU WE TH FR SA SU	-----	-----	MO TU WE TH FR SA SU	-----	-----	MO TU WE TH FR SA SU	
Expert	1214	Start hour (AUX 1)	hh:mm	07:00	00:00	23:59	07:00	00:00	23:59	07:00	00:00	23:59	
Expert	1215	End hour (AUX 1)	hh:mm	20:00	00:00	23:59	20:00	00:00	23:59	20:00	00:00	23:59	
Inst.	1216	Program 4 (AUX 1)											
Inst.	1217	Day of the week (AUX 1)	days	-----	-----	MO TU WE TH FR SA SU	-----	-----	MO TU WE TH FR SA SU	-----	-----	MO TU WE TH FR SA SU	
Inst.	1218	Start hour (AUX 1)	hh:mm	07:00	00:00	23:59	07:00	00:00	23:59	07:00	00:00	23:59	
Inst.	1219	End hour (AUX 1)	hh:mm	20:00	00:00	23:59	20:00	00:00	23:59	20:00	00:00	23:59	
Inst.	1220	Program 5 (AUX 1)											
Inst.	1221	Day of the week (AUX 1)	days	-----	-----	MO TU WE TH FR SA SU	-----	-----	MO TU WE TH FR SA SU	-----	-----	MO TU WE TH FR SA SU	
Inst.	1222	Start hour (AUX 1)	hh:mm	07:00	00:00	23:59	07:00	00:00	23:59	07:00	00:00	23:59	
Inst.	1223	End hour (AUX 1)	hh:mm	20:00	00:00	23:59	20:00	00:00	23:59	20:00	00:00	23:59	
Expert	1269	Contact active with a fixed time schedule (AUX 1)											
Expert	1270	Program 1 (AUX 1)											
Expert	1271	Day of the week (AUX 1)	days	-----	-----	MO TU WE TH FR SA SU	-----	-----	MO TU WE TH FR SA SU	-----	-----	MO TU WE TH FR SA SU	
Expert	1272	Start hour (AUX 1)	hh:mm	07:00	00:00	23:59	07:00	00:00	23:59	07:00	00:00	23:59	
Expert	1273	End hour (AUX 1)	hh:mm	20:00	00:00	23:59	20:00	00:00	23:59	20:00	00:00	23:59	
Expert	1274	Program 2 (AUX 1)											
Expert	1275	Day of the week (AUX 1)	days	-----	-----	MO TU WE TH FR SA SU	-----	-----	MO TU WE TH FR SA SU	-----	-----	MO TU WE TH FR SA SU	
Expert	1276	Start hour (AUX 1)	hh:mm	07:00	00:00	23:59	07:00	00:00	23:59	07:00	00:00	23:59	
Expert	1277	End hour (AUX 1)	hh:mm	20:00	00:00	23:59	20:00	00:00	23:59	20:00	00:00	23:59	
Expert	1278	Program 3 (AUX 1)											
Expert	1279	Day of the week (AUX 1)	days	-----	-----	MO TU WE TH FR SA SU	-----	-----	MO TU WE TH FR SA SU	-----	-----	MO TU WE TH FR SA SU	
Expert	1280	Start hour (AUX 1)	hh:mm	07:00	00:00	23:59	07:00	00:00	23:59	07:00	00:00	23:59	
Expert	1281	End hour (AUX 1)	hh:mm	20:00	00:00	23:59	20:00	00:00	23:59	20:00	00:00	23:59	
Expert	1455	Contact active on event (AUX 1)											
Expert	1225	WPC OFF (AUX 1)	No/Yes	No	No	Yes	No	No	Yes	No	No	Yes	
Expert	1518	WPC ON (AUX 1)	No/Yes	No	No	Yes	No	No	Yes	No	No	Yes	



INVERTER PARAMETERS

Level	User ref.	Parameter	Unit	12			24			48			Modi. val
				Factory	Min	Max	Factory	Min	Max	Factory	Min	Max	
Expert	1543	Remote entry (AUX 1)	No/Yes	No	No	Yes	No	No	Yes	No	No	Yes	
Expert	1226	Battery undervoltage (AUX 1)	No/Yes	No	No	Yes	No	No	Yes	No	No	Yes	
Expert	1227	Battery overvoltage (AUX 1)	No/Yes	No	No	Yes	No	No	Yes	No	No	Yes	
Expert	1228	Inverter or Smart- Boost overload (AUX 1)	No/Yes	No	No	Yes	No	No	Yes	No	No	Yes	
Expert	1229	Overtemperature (AUX 1)	No/Yes	No	No	Yes	No	No	Yes	No	No	Yes	
Expert	1520	No overtemperature (AUX 1)	No/Yes	No	No	Yes	No	No	Yes	No	No	Yes	
Expert	1231	Active charger (AUX 1)	No/Yes	No	No	Yes	No	No	Yes	No	No	Yes	
Expert	1232	Active inverter (AUX 1)	No/Yes	No	No	Yes	No	No	Yes	No	No	Yes	
Expert	1233	Active Smart-Boost (AUX 1)	No/Yes	No	No	Yes	No	No	Yes	No	No	Yes	
Expert	1234	AC input presence but with fault (AUX 1)	No/Yes	No	No	Yes	No	No	Yes	No	No	Yes	
Expert	1235	AC input presence (AUX 1)	No/Yes	No	No	Yes	No	No	Yes	No	No	Yes	
Expert	1236	Transfer relay ON (AUX 1)	No/Yes	No	No	Yes	No	No	Yes	No	No	Yes	
Expert	1237	AC out presence (AUX 1)	No/Yes	No	No	Yes	No	No	Yes	No	No	Yes	
Expert	1238	Bulk charge phase (AUX 1)	No/Yes	No	No	Yes	No	No	Yes	No	No	Yes	
Expert	1239	Absorption phase (AUX 1)	No/Yes	No	No	Yes	No	No	Yes	No	No	Yes	
Expert	1240	Equalization phase (AUX 1)	No/Yes	No	No	Yes	No	No	Yes	No	No	Yes	
Expert	1242	Floating (AUX 1)	No/Yes	No	No	Yes	No	No	Yes	No	No	Yes	
Expert	1243	Reduced floating (AUX 1)	No/Yes	No	No	Yes	No	No	Yes	No	No	Yes	
Expert	1244	Periodic absorption (AUX 1)	No/Yes	No	No	Yes	No	No	Yes	No	No	Yes	
Expert	1529	Autonomy test running (AUX 1)	No/Yes	No	No	Yes	No	No	Yes	No	No	Yes	
Expert	1245	Contact active according to battery voltage (AUX 1)											
Expert	1288	Use dynamic compensation of battery level (AUX 1)	No/Yes	Yes	No	Yes	Yes	No	Yes	Yes	No	Yes	
Expert	1246	Battery voltage 1 activate (AUX 1)	No/Yes	Yes	No	Yes	Yes	No	Yes	Yes	No	Yes	
Expert	1247	Battery voltage 1 (AUX 1)	Vdc	11.8	9	18	23.6	18	36	47.2	36	72	
Expert	1248	Delay 1 (AUX 1)	min	1	0	60	1	0	60	1	0	60	
Expert	1249	Battery voltage 2 activate (AUX 1)	No/Yes	Yes	No	Yes	Yes	No	Yes	Yes	No	Yes	
Expert	1250	Battery voltage 2 (AUX 1)	Vdc	12	9	18	24	18	36	48	36	72	
Expert	1251	Delay 2 (AUX 1)	min	10	0	60	10	0	60	10	0	60	
Expert	1252	Battery voltage 3 activate (AUX 1)	No/Yes	Yes	No	Yes	Yes	No	Yes	Yes	No	Yes	
Expert	1253	Battery voltage 3 (AUX 1)	Vdc	12.2	9	18	24.4	18	36	48.8	36	72	
Expert	1254	Delay 3 (AUX 1)	min	60	0	60	60	0	60	60	0	60	
Expert	1255	Battery voltage to deactivate (AUX 1)	Vdc	13.6	9	18	27.2	18	36	54.4	36	72	
Expert	1256	Delay to deactivate (AUX 1)	min	120	0	480	120	0	480	120	0	480	
Expert	1516	Deactivate if battery in floating phase (AUX 1)	No/Yes	Yes	No	Yes	Yes	No	Yes	Yes	No	Yes	



INVERTER PARAMETERS

Level	User ref.	Parameter	Unit	12			24			48			Modi. val
				Factory	Min	Max	Factory	Min	Max	Factory	Min	Max	
Expert	1257	Contact active with inverter power or Smart-Boost (AUX 1)											
Expert	1258	Inverter power level 1 activate (AUX 1)	No/Yes	Yes	No	Yes	Yes	No	Yes	Yes	No	Yes	
Expert	1259	Power level 1 (AUX 1)	% Pnom	70	20	120	70	20	120	70	20	120	
Expert	1260	Time delay 1 (AUX 1)	min	15	0	60	15	0	60	15	0	60	
Expert	1261	Inverter power level 2 activate (AUX 1)	No/Yes	Yes	No	Yes	Yes	No	Yes	Yes	No	Yes	
Expert	1262	Power level 2 (AUX 1)	% Pnom	100	20	120	100	20	120	100	20	120	
Expert	1263	Time delay 2 (AUX 1)	min	5	0	60	5	0	60	5	0	60	
Expert	1264	Inverter power level 3 activate (AUX 1)	No/Yes	Yes	No	Yes	Yes	No	Yes	Yes	No	Yes	
Expert	1265	Power level 3 (AUX 1)	% Pnom	110	20	120	110	20	120	110	20	120	
Expert	1266	Time delay 3 (AUX 1)	min	1	0	60	1	0	60	1	0	60	
Expert	1267	Inverter power level to deactivate (AUX 1)	% Pnom	40	20	120	40	20	120	40	20	120	
Expert	1268	Time delay to deactivate (AUX 1)	min	5	0	60	5	0	60	5	0	60	
Inst.	1503	Contact active according to battery temperature (AUX 1) With BSP or BTS											
Inst.	1446	Contact activated with the temperature of battery (AUX 1)	No/Yes	No	No	Yes	No	No	Yes	No	No	Yes	
Inst.	1447	Contact activated over (AUX 1)	°C	3	-10	50	3	-10	50	3	-10	50	
Inst.	1448	Contact deactivated below (AUX 1)	°C	5	-10	50	5	-10	50	5	-10	50	
Expert	1501	Contact active according to SOC (AUX 1) Only with BSP											
Expert	1439	Contact activated with the SOC 1 of battery (AUX 1)	No/Yes	No	No	Yes	No	No	Yes	No	No	Yes	
Expert	1440	Contact activated below SOC 1 (AUX 1)	% SOC	50	0	100	50	0	100	50	0	100	
Expert	1581	Delay 1 (AUX 1)	h	12	0	99	12	0	99	12	0	99	
Expert	1582	Contact activated with the SOC 2 of battery (AUX 1)	No/Yes	No	No	Yes	No	No	Yes	No	No	Yes	
Expert	1583	Contact activated below SOC 2 (AUX 1)	%	30	0	100	30	0	100	30	0	100	
Expert	1584	Delay 2 (AUX 1)	h	.2	0	99	.2	0	99	.2	0	99	
Expert	1585	Contact activated with the SOC 3 of battery (AUX 1)	No/Yes	No	No	Yes	No	No	Yes	No	No	Yes	
Expert	1586	Contact activated below SOC 3 (AUX 1)	%	20	0	100	20	0	100	20	0	100	
Expert	1587	Delay 3 (AUX 1)	h	0	0	99	0	0	99	0	0	99	
Expert	1441	Contact deactivated over SOC (AUX 1)	% SOC	90	0	100	90	0	100	90	0	100	
Expert	1588	Delay to deactivate (AUX 1)	h	.2	0	10	.2	0	10	.2	0	10	
Expert	1589	Deactivate if battery in floating phase (AUX 1)	No/Yes	Yes	No	Yes	Yes	No	Yes	Yes	No	Yes	
Expert	1512	Security, maximum time of contact (AUX 1)	No/Yes	No	No	Yes	No	No	Yes	No	No	Yes	
Expert	1514	Maximum time of operation of contact (AUX 1)	min	600	10	1200	600	10	1200	600	10	1200	
Expert	1569	Reset all settings (AUX 1)		S	S	S	S	S	S	S	S	S	
Expert	1310	AUXILIARY CONTACT 2											



INVERTER PARAMETERS

Level	User ref.	Parameter	Unit	12			24			48			Modi. val
				Factory	Min	Max	Factory	Min	Max	Factory	Min	Max	
Expert	1311	Operating mode (AUX 2)	Text	Automatic	Automatic	Manual OFF	Automatic	Automatic	Manual OFF	Automatic	Automatic	Manual OFF	
Expert	1498	Combination of the events for the auxiliary contact (AUX 2)	Text	Any (Function OR)	Any (Function OR)	All (Function AND)	Any (Function OR)	Any (Function OR)	All (Function AND)	Any (Function OR)	Any (Function OR)	All (Function AND)	
Expert	1312	Temporal restrictions (AUX 2)											
Expert	1313	Program 1 (AUX 2)											
Expert	1314	Day of the week (AUX 2)	days	----- ---	----- ---	MO TU WE TH FR SA SU	----- ---	----- ---	MO TU WE TH FR SA SU	----- ---	----- ---	MO TU WE TH FR SA SU	
Expert	1315	Start hour (AUX 2)	hh:mm	07:00	00:00	23:59	07:00	00:00	23:59	07:00	00:00	23:59	
Expert	1316	End hour (AUX 2)	hh:mm	20:00	00:00	23:59	20:00	00:00	23:59	20:00	00:00	23:59	
Expert	1317	Program 2 (AUX 2)											
Expert	1318	Day of the week (AUX 2)	days	----- ---	----- ---	MO TU WE TH FR SA SU	----- ---	----- ---	MO TU WE TH FR SA SU	----- ---	----- ---	MO TU WE TH FR SA SU	
Expert	1319	Start hour (AUX 2)	hh:mm	07:00	00:00	23:59	07:00	00:00	23:59	07:00	00:00	23:59	
Expert	1320	End hour (AUX 2)	hh:mm	20:00	00:00	23:59	20:00	00:00	23:59	20:00	00:00	23:59	
Expert	1321	Program 3 (AUX 2)											
Expert	1322	Day of the week (AUX 2)	days	----- ---	----- ---	MO TU WE TH FR SA SU	----- ---	----- ---	MO TU WE TH FR SA SU	----- ---	----- ---	MO TU WE TH FR SA SU	
Expert	1323	Start hour (AUX 2)	hh:mm	07:00	00:00	23:59	07:00	00:00	23:59	07:00	00:00	23:59	
Expert	1324	End hour (AUX 2)	hh:mm	20:00	00:00	23:59	20:00	00:00	23:59	20:00	00:00	23:59	
Inst.	1325	Program 4 (AUX 2)											
Inst.	1326	Day of the week (AUX 2)	days	----- ---	----- ---	MO TU WE TH FR SA SU	----- ---	----- ---	MO TU WE TH FR SA SU	----- ---	----- ---	MO TU WE TH FR SA SU	
Inst.	1327	Start hour (AUX 2)	hh:mm	07:00	00:00	23:59	07:00	00:00	23:59	07:00	00:00	23:59	
Inst.	1328	End hour (AUX 2)	hh:mm	20:00	00:00	23:59	20:00	00:00	23:59	20:00	00:00	23:59	
Inst.	1329	Program 5 (AUX 2)											
Inst.	1330	Day of the week (AUX 2)	days	----- ---	----- ---	MO TU WE TH FR SA SU	----- ---	----- ---	MO TU WE TH FR SA SU	----- ---	----- ---	MO TU WE TH FR SA SU	
Inst.	1331	Start hour (AUX 2)	hh:mm	07:00	00:00	23:59	07:00	00:00	23:59	07:00	00:00	23:59	
Inst.	1332	End hour (AUX 2)	hh:mm	20:00	00:00	23:59	20:00	00:00	23:59	20:00	00:00	23:59	
Expert	1378	Contact active with a fixed time schedule (AUX 2)											
Expert	1379	Program 1 (AUX 2)											
Expert	1380	Day of the week (AUX 2)	days	----- ---	----- ---	MO TU WE TH FR SA SU	----- ---	----- ---	MO TU WE TH FR SA SU	----- ---	----- ---	MO TU WE TH FR SA SU	



INVERTER PARAMETERS

Level	User ref.	Parameter	Unit	12			24			48			Modi. val
				Factory	Min	Max	Factory	Min	Max	Factory	Min	Max	
Expert	1381	Start hour (AUX 2)	hh:mm	07:00	00:00	23:59	07:00	00:00	23:59	07:00	00:00	23:59	
Expert	1382	End hour (AUX 2)	hh:mm	20:00	00:00	23:59	20:00	00:00	23:59	20:00	00:00	23:59	
Expert	1383	Program 2 (AUX 2)											
Expert	1384	Day of the week (AUX 2)	days	--- --	---	MO TU WE TH FR SA SU	--- --	---	MO TU WE TH FR SA SU	--- --	---	MO TU WE TH FR SA SU	
Expert	1385	Start hour (AUX 2)	hh:mm	07:00	00:00	23:59	07:00	00:00	23:59	07:00	00:00	23:59	
Expert	1386	End hour (AUX 2)	hh:mm	20:00	00:00	23:59	20:00	00:00	23:59	20:00	00:00	23:59	
Expert	1387	Program 3 (AUX 2)											
Expert	1388	Day of the week (AUX 2)	days	--- --	---	MO TU WE TH FR SA SU	--- --	---	MO TU WE TH FR SA SU	--- --	---	MO TU WE TH FR SA SU	
Expert	1389	Start hour (AUX 2)	hh:mm	07:00	00:00	23:59	07:00	00:00	23:59	07:00	00:00	23:59	
Expert	1390	End hour (AUX 2)	hh:mm	20:00	00:00	23:59	20:00	00:00	23:59	20:00	00:00	23:59	
Expert	1456	Contact active on event (AUX 2)											
Expert	1333	WPC OFF (AUX 2)	No/Yes	No	No	Yes	No	No	Yes	No	No	Yes	
Expert	1519	WPC ON (AUX 2)	No/Yes	No	No	Yes	No	No	Yes	No	No	Yes	
Expert	1544	Remote entry (AUX 2)	No/Yes	No	No	Yes	No	No	Yes	No	No	Yes	
Expert	1334	Battery undervoltage (AUX 2)	No/Yes	No	No	Yes	No	No	Yes	No	No	Yes	
Expert	1335	Battery overvoltage (AUX 2)	No/Yes	No	No	Yes	No	No	Yes	No	No	Yes	
Expert	1336	Inverter or Smart-Boost overload (AUX 2)	No/Yes	No	No	Yes	No	No	Yes	No	No	Yes	
Expert	1337	Overtemperature (AUX 2)	No/Yes	No	No	Yes	No	No	Yes	No	No	Yes	
Expert	1521	No overtemperature (AUX 2)	No/Yes	No	No	Yes	No	No	Yes	No	No	Yes	
Expert	1339	Active charger (AUX 2)	No/Yes	No	No	Yes	No	No	Yes	No	No	Yes	
Expert	1340	Active inverter (AUX 2)	No/Yes	No	No	Yes	No	No	Yes	No	No	Yes	
Expert	1341	Active Smart-Boost (AUX 2)	No/Yes	No	No	Yes	No	No	Yes	No	No	Yes	
Expert	1342	AC input presence but with fault (AUX 2)	No/Yes	No	No	Yes	No	No	Yes	No	No	Yes	
Expert	1343	AC input presence (AUX 2)	No/Yes	No	No	Yes	No	No	Yes	No	No	Yes	
Expert	1344	Transfer contact ON (AUX 2)	No/Yes	Yes	No	Yes	Yes	No	Yes	Yes	No	Yes	
Expert	1345	AC out presence (AUX 2)	No/Yes	No	No	Yes	No	No	Yes	No	No	Yes	
Expert	1346	Bulk charge phase (AUX 2)	No/Yes	No	No	Yes	No	No	Yes	No	No	Yes	
Expert	1347	Absorption phase (AUX 2)	No/Yes	No	No	Yes	No	No	Yes	No	No	Yes	
Expert	1348	Equalization phase (AUX 2)	No/Yes	No	No	Yes	No	No	Yes	No	No	Yes	
Expert	1350	Floating (AUX 2)	No/Yes	No	No	Yes	No	No	Yes	No	No	Yes	
Expert	1351	Reduced floating (AUX 2)	No/Yes	No	No	Yes	No	No	Yes	No	No	Yes	



INVERTER PARAMETERS

Level	User ref.	Parameter	Unit	12			24			48			Modi. val
				Factory	Min	Max	Factory	Min	Max	Factory	Min	Max	
Expert	1352	Periodic absorption (AUX 2)	No/Yes	No	No	Yes	No	No	Yes	No	No	Yes	
Expert	1530	Autonomy test running (AUX 2)	No/Yes	No	No	Yes	No	No	Yes	No	No	Yes	
Expert	1353	Contact active according to battery voltage (AUX 2)											
Expert	1354	Use dynamic compensation of battery level (AUX 2)	No/Yes	No	No	Yes	No	No	Yes	No	No	Yes	
Expert	1355	Battery voltage 1 activate (AUX 2)	No/Yes	No	No	Yes	No	No	Yes	No	No	Yes	
Expert	1356	Battery voltage 1 (AUX 2)	Vdc	12	9	18	24	18	36	48	36	72	
Expert	1357	Delay 1 (AUX 2)	min	5	0	60	5	0	60	5	0	60	
Expert	1358	Battery voltage 2 activate (AUX 2)	No/Yes	No	No	Yes	No	No	Yes	No	No	Yes	
Expert	1359	Battery voltage 2 (AUX 2)	Vdc	11.5	9	18	23	18	36	46.1	36	72	
Expert	1360	Delay 2 (AUX 2)	min	5	0	60	5	0	60	5	0	60	
Expert	1361	Battery voltage 3 activate (AUX 2)	No/Yes	No	No	Yes	No	No	Yes	No	No	Yes	
Expert	1362	Battery voltage 3 (AUX 2)	Vdc	11	9	18	22.1	18	36	44.2	36	72	
Expert	1363	Delay 3 (AUX 2)	min	5	0	60	5	0	60	5	0	60	
Expert	1364	Battery voltage to deactivate (AUX 2)	Vdc	12.6	9	18	25.2	18	36	50.4	36	72	
Expert	1365	Delay to deactivate (AUX 2)	min	5	0	480	5	0	480	5	0	480	
Expert	1517	Deactivate if battery in floating phase (AUX 2)	No/Yes	No	No	Yes	No	No	Yes	No	No	Yes	
Expert	1366	Contact active with inverter power or Smart-Boost (AUX 2)											
Expert	1367	Inverter power level 1 activate (AUX 2)	No/Yes	No	No	Yes	No	No	Yes	No	No	Yes	
Expert	1368	Power level 1 (AUX 2)	% Pnom	120	20	120	120	20	120	120	20	120	
Expert	1369	Time delay 1 (AUX 2)	min	0	0	60	0	0	60	0	0	60	
Expert	1370	Inverter power level 2 activate (AUX 2)	No/Yes	No	No	Yes	No	No	Yes	No	No	Yes	
Expert	1371	Power level 2 (AUX 2)	% Pnom	80	20	120	80	20	120	80	20	120	
Expert	1372	Time delay 2 (AUX 2)	min	5	0	60	5	0	60	5	0	60	
Expert	1373	Inverter power level 3 activate (AUX 2)	No/Yes	No	No	Yes	No	No	Yes	No	No	Yes	
Expert	1374	Power level 3 (AUX 2)	% Pnom	50	20	120	50	20	120	50	20	120	
Expert	1375	Time delay 3 (AUX 2)	min	30	0	60	30	0	60	30	0	60	
Expert	1376	Inverter power level to deactivate (AUX 2)	% Pnom	40	20	120	40	20	120	40	20	120	
Expert	1377	Time delay to deactivate (AUX 2)	min	5	0	60	5	0	60	5	0	60	
Inst.	1504	Contact active according to battery temperature (AUX 2) With BSP or BTS											
Inst.	1457	Contact activated with the temperature of battery (AUX 2)	No/Yes	No	No	Yes	No	No	Yes	No	No	Yes	
Inst.	1458	Contact activated over (AUX 2)	°C	3	-10	50	3	-10	50	3	-10	50	
Inst.	1459	Contact deactivated below (AUX 2)	°C	5	-10	50	5	-10	50	5	-10	50	
Inst.	1460	Contact activated only if the battery is charged (AUX 2)	No/Yes	No	No	Yes	No	No	Yes	No	No	Yes	



INVERTER PARAMETERS

Level	User ref.	Parameter	Unit	12			24			48			Modi. val
				Factory	Min	Max	Factory	Min	Max	Factory	Min	Max	
Expert	1502	Contact active according to SOC (AUX 2) Only with BSP											
Expert	1442	Contact activated with the SOC 1 of battery (AUX 2)	No/Yes	No	No	Yes	No	No	Yes	No	No	Yes	
Expert	1443	Contact activated below SOC 1 (AUX 2)	% SOC	50	0	100	50	0	100	50	0	100	
Expert	1590	Delay 1 (AUX 2)	h	12	0	99	12	0	99	12	0	99	
Expert	1591	Contact activated with the SOC 2 of battery (AUX 2)	No/Yes	No	No	Yes	No	No	Yes	No	No	Yes	
Expert	1592	Contact activated below SOC 2 (AUX 2)	%	30	0	100	30	0	100	30	0	100	
Expert	1593	Delay 2 (AUX 2)	h	.2	0	99	.2	0	99	.2	0	99	
Expert	1594	Contact activated with the SOC 3 of battery (AUX 2)	No/Yes	No	No	Yes	No	No	Yes	No	No	Yes	
Expert	1595	Contact activated below SOC 3 (AUX 2)	%	20	0	100	20	0	100	20	0	100	
Expert	1596	Delay 3 (AUX 2)	h	0	0	99	0	0	99	0	0	99	
Expert	1444	Contact deactivated over SOC (AUX 2)	% SOC	90	0	100	90	0	100	90	0	100	
Expert	1597	Delay to deactivate (AUX 2)	h	.2	0	10	.2	0	10	.2	0	10	
Expert	1598	Deactivate if battery in floating phase (AUX 2)	No/Yes	Yes	No	Yes	Yes	No	Yes	Yes	No	Yes	
Expert	1513	Security, maximum time of contact (AUX 2)	No/Yes	No	No	Yes	No	No	Yes	No	No	Yes	
Expert	1515	Maximum time of operation of contact (AUX 2)	min	600	10	1200	600	10	1200	600	10	1200	
Expert	1570	Reset all settings (AUX 2)		S	S	S	S	S	S	S	S	S	
Expert	1101	SYSTEM											
Expert	1537	Remote entry (Remote ON/OFF)											
Expert	1545	Remote entry active	Closed/O pen	Closed	Closed	Open	Closed	Closed	Open	Closed	Closed	Open	
Expert	1538	Prohibits transfert relay	No/Yes	No	No	Yes	No	No	Yes	No	No	Yes	
Expert	1539	Prohibits inverter	No/Yes	No	No	Yes	No	No	Yes	No	No	Yes	
Expert	1540	Prohibits charger	No/Yes	No	No	Yes	No	No	Yes	No	No	Yes	
Expert	1541	Prohibits Smart-Boost	No/Yes	No	No	Yes	No	No	Yes	No	No	Yes	
Expert	1542	Prohibits grid feeding	No/Yes	No	No	Yes	No	No	Yes	No	No	Yes	
Expert	1576	ON/OFF command	No/Yes	No	No	Yes	No	No	Yes	No	No	Yes	
Inst.	1578	Activated by AUX1 state	No/Yes	No	No	Yes	No	No	Yes	No	No	Yes	
Inst.	1579	Prohibits battery priority	No/Yes	No	No	Yes	No	No	Yes	No	No	Yes	
Expert	1296	Batteries priority as energy source	No/Yes	No	No	Yes	No	No	Yes	No	No	Yes	
Expert	1297	Battery priority voltage	Vdc	12.9	9.5	18	25.8	19	36	51.6	37.9	72	
Expert	1565	Buzzer alarm duration	min	0	0	60	0	0	60	0	0	60	
Expert	1129	Auto restarts											
Expert	1130	After battery undervoltage	No/Yes	Yes	No	Yes	Yes	No	Yes	Yes	No	Yes	
Expert	1304	Number of batteries undervoltage allowed before definitive stop		3	1	20	3	1	20	3	1	20	



INVERTER PARAMETERS

Level	User ref.	Parameter	Unit	12			24			48			Modi. val
				Factory	Min	Max	Factory	Min	Max	Factory	Min	Max	
Expert	1404	Time period for batteries undervoltages counting	sec	0	0	3000	0	0	3000	0	0	3000	
Expert	1305	Number of batteries critical undervoltage allowed before definitive stop		10	1	20	10	1	20	10	1	20	
Expert	1405	Time period for critical batteries undervoltages counting	sec	10	0	3000	10	0	3000	10	0	3000	
Expert	1131	After battery overvoltage	No/Yes	Yes	No	Yes	Yes	No	Yes	Yes	No	Yes	
Expert	1132	After inverter or Smart-Boost overload	No/Yes	Yes	No	Yes	Yes	No	Yes	Yes	No	Yes	
Expert	1533	Delay to restart after an overload	sec	5	2	120	5	2	120	5	2	120	
Expert	1134	After overtemperature	No/Yes	Yes	No	Yes	Yes	No	Yes	Yes	No	Yes	
Expert	1111	Autostart to the battery connection	No/Yes	No	No	Yes	No	No	Yes	No	No	Yes	
Expert	1484	System earthing (Earth - Neutral)											
Expert	1485	Prohibited ground relay	No/Yes	Yes	No	Yes	Yes	No	Yes	Yes	No	Yes	
Expert	1486	Continuous neutral	No/Yes	No	No	Yes	No	No	Yes	No	No	Yes	
Expert	1473	Autotest of the battery autonomy											
Expert	1474	Functionality test (weekly)	No/Yes	No	No	Yes	No	No	Yes	No	No	Yes	
Expert	1495	Start manually a functionality test (weekly)		S	S	S	S	S	S	S	S	S	
Expert	1475	Day in the week of the test		----- ---	----- -----	MO TU WE TH FR SA SU	----- ---	----- -----	MO TU WE TH FR SA SU	----- ---	----- -----	MO TU WE TH FR SA SU	
Expert	1476	Hour of the beginning of the test	hh:mm	07:00	00:00	23:59	07:00	00:00	23:59	07:00	00:00	23:59	
Expert	1477	Duration of the test	min	60	0	480	60	0	480	60	0	480	
Expert	1478	Autonomy test (monthly)	No/Yes	No	No	Yes	No	No	Yes	No	No	Yes	
Expert	1496	Start manually an autonomy test (monthly)		S	S	S	S	S	S	S	S	S	
Expert	1479	Months of the test		----- -	----- -	JFMAMJJA SOND	----- -	----- -	JFMAMJJA SOND	----- -	----- -	JFMAMJJA SOND	
Expert	1480	Day in the month of the test		1	1	31	1	1	31	1	1	31	
Expert	1481	Day in the week of the test		----- ---	----- -----	MO TU WE TH FR SA SU	----- ---	----- -----	MO TU WE TH FR SA SU	----- ---	----- -----	MO TU WE TH FR SA SU	
Expert	1482	Hour of the beginning of the test	hh:mm	07:00	00:00	23:59	07:00	00:00	23:59	07:00	00:00	23:59	
Expert	1483	Duration of the test	min	60	0	480	60	0	480	60	0	480	
Inst.	1550	Parameters saved in flash memory	No/Yes	Yes	No	Yes	Yes	No	Yes	Yes	No	Yes	
Expert	1468	Reset of all the inverters		S	S	S	S	S	S	S	S	S	
Expert	1282	MULTI WPC											
Expert	1283	Integral mode for the three phase system	No/Yes	No	No	Yes	No	No	Yes	No	No	Yes	
Expert	1461	Multi inverters allowed	Yes/No	Yes	Yes	No	Yes	Yes	No	Yes	Yes	No	
Expert	1462	Multi inverters independents	No/Yes	No	No	Yes	No	No	Yes	No	No	Yes	
Expert	1547	Allow slaves standby in multi-WPC system	No/Yes	Yes	No	Yes	Yes	No	Yes	Yes	No	Yes	



INVERTER PARAMETERS

Level	User ref.	Parameter	Unit	12			24			48			Modi. val
				Factory	Min	Max	Factory	Min	Max	Factory	Min	Max	
Expert	1571	Splitphase: L2 with 180 degrees phaseshift	No/Yes	No	No	Yes	No	No	Yes	No	No	Yes	
Inst.	1437	Minigrid compatible	No/Yes	No	No	Yes	No	No	Yes	No	No	Yes	
Inst.	1577	Minigrid with shared battery energy	No/Yes	Yes	No	Yes	Yes	No	Yes	Yes	No	Yes	
Expert	1522	GRID-FEEDING											
Expert	1127	Grid feeding allowed	Yes/No	No	Yes	No	No	Yes	No	No	Yes	No	
Expert	1523	Max grid feeding current	Aac	10	0	50	10	0	50	10	0	50	
Expert	1524	Battery voltage target for forced grid feeding	Vdc	12	9.5	18	24	19	36	48	37.9	72	
Expert	1525	Forced grid feeding start time	hh:mm	20:00	00:00	23:59	20:00	00:00	23:59	20:00	00:00	23:59	
Expert	1526	Forced grid feeding stop time	hh:mm	20:00	00:00	23:59	20:00	00:00	23:59	20:00	00:00	23:59	



INDEX OF THE NUMBERS OF PARAMETERS {XXXX}

{1100}.....	37	{1173}.....	51	{1238}.....	63
{1101}.....	65	{1174}.....	51, 74	{1239}.....	63
{1107}.....	17, 18, 20, 30, 31, 37, 38, 44, 56, 71	{1175}.....	51	{1240}.....	63
{1108}.....	29, 44, 74	{1176}.....	51	{1242}.....	63
{1109}.....	45, 74	{1186}.....	51	{1243}.....	63
{1110}.....	45, 74	{1187}.....	38, 39, 54	{1244}.....	63
{1111}.....	68	{1188}.....	55	{1245}.....	63
{1112}.....	52, 59, 71	{1189}.....	54	{1246}.....	63
{1121}.....	46, 74	{1190}.....	44, 45	{1247}.....	63
{1122}.....	46, 74	{1191}.....	45	{1248}.....	63
{1124}.....	38, 51	{1194}.....	45	{1249}.....	63
{1125}.....	44	{1195}.....	45, 74	{1250}.....	63
{1126}.....	38, 56, 59	{1196}.....	29, 45	{1251}.....	63
{1126}.....	18	{1197}.....	55	{1252}.....	63
{1127}.....	70	{1198}.....	55, 57	{1253}.....	63
{1128}.....	55	{1199}.....	55, 57, 58, 74	{1254}.....	63
{1129}.....	67	{1200}.....	55, 57, 74	{1255}.....	63
{1130}.....	67	{1201}.....	59	{1256}.....	63
{1131}.....	67	{1202}.....	60	{1257}.....	64
{1132}.....	67	{1203}.....	60	{1258}.....	64
{1134}.....	67	{1204}.....	60	{1259}.....	64
{1137}.....	40	{1205}.....	61	{1260}.....	64
{1138}.....	17, 38, 44, 49	{1206}.....	61	{1261}.....	64
{1139}.....	44	{1207}.....	61	{1262}.....	64
{1140}.....	46, 53, 74	{1208}.....	61	{1263}.....	64
{1141}.....	46	{1209}.....	61	{1264}.....	64
{1142}.....	46	{1210}.....	61	{1265}.....	64
{1143}.....	46	{1211}.....	61	{1266}.....	64
{1144}.....	46	{1212}.....	61	{1267}.....	64
{1145}.....	46	{1213}.....	61	{1268}.....	64
{1146}.....	46	{1214}.....	61	{1269}.....	61
{1147}.....	47	{1215}.....	61	{1270}.....	61
{1148}.....	47	{1216}.....	61	{1271}.....	61
{1149}.....	47	{1217}.....	61	{1272}.....	61
{1155}.....	47	{1218}.....	61	{1273}.....	61
{1156}.....	47, 74	{1219}.....	61	{1274}.....	61
{1157}.....	47	{1220}.....	61	{1275}.....	61
{1158}.....	48	{1221}.....	61	{1276}.....	61
{1159}.....	48	{1222}.....	61	{1277}.....	61
{1160}.....	48	{1223}.....	61	{1278}.....	61
{1161}.....	48	{1225}.....	61	{1279}.....	61
{1162}.....	48	{1226}.....	62	{1280}.....	61
{1163}.....	48	{1227}.....	62	{1281}.....	61
{1164}.....	49, 74	{1228}.....	62	{1282}.....	70
{1165}.....	49	{1229}.....	62	{1283}.....	70
{1166}.....	49	{1231}.....	59, 62	{1284}.....	49
{1168}.....	50	{1232}.....	62	{1285}.....	49, 50
{1169}.....	50	{1233}.....	62	{1286}.....	52
{1170}.....	50	{1234}.....	62	{1287}.....	39
{1171}.....	50	{1235}.....	62	{1288}.....	63, 64
{1172}.....	50, 74	{1236}.....	62	{1290}.....	49
		{1237}.....	63	{1291}.....	49



INVERTER PARAMETERS

{1295}.....58	{1360}.....63	{1458}.....64
{1296}.....66	{1361}.....63	{1459}.....64
{1297}.....67	{1362}.....63	{1461}.....70
{1298}.....45	{1363}.....63	{1462}.....70
{1304}.....67	{1364}.....63	{1467}.....46
{1305}.....67	{1365}.....63	{1468}.....69
{1307}.....45	{1366}.....64	{1469}.....45
{1309}.....55, 58	{1367}.....64	{1471}.....57
{1310}.....59	{1368}.....64	{1473}.....68
{1311}.....60	{1369}.....64	{1474}.....68
{1312}.....60	{1370}.....64	{1475}.....68
{1313}.....60	{1371}.....64	{1476}.....69
{1314}.....61	{1372}.....64	{1477}.....69
{1315}.....61	{1373}.....64	{1478}.....69
{1316}.....61	{1374}.....64	{1479}.....69
{1317}.....61	{1375}.....64	{1480}.....69
{1318}.....61	{1376}.....64	{1481}.....69
{1319}.....61	{1377}.....64	{1482}.....69
{1320}.....61	{1378}.....61	{1483}.....69
{1321}.....61	{1379}.....61	{1484}.....68
{1322}.....61	{1380}.....61	{1485}.....68
{1323}.....61	{1381}.....61	{1486}.....68
{1324}.....61	{1382}.....61	{1495}.....68
{1325}.....61	{1383}.....61	{1496}.....69
{1326}.....61	{1384}.....61	{1505}.....52, 59
{1327}.....61	{1385}.....61	{1506}.....52, 59
{1328}.....61	{1386}.....61	{1507}.....59
{1329}.....61	{1387}.....61	{1510}.....38, 57
{1330}.....61	{1388}.....61	{1512}.....33, 65
{1331}.....61	{1389}.....61	{1513}.....33, 65
{1332}.....61	{1390}.....61	{1514}.....33, 65
{1333}.....61	{1395}.....39	{1515}.....33, 65
{1334}.....62	{1404}.....67	{1516}.....63, 64
{1335}.....62	{1405}.....67	{1517}.....63, 64
{1336}.....62	{1420}.....54	{1518}.....61
{1337}.....62	{1432}.....57	{1519}.....61
{1339}.....59, 62	{1433}.....58	{1520}.....62
{1340}.....62	{1435}.....56	{1521}.....62
{1341}.....62	{1436}.....31, 56	{1522}.....70
{1342}.....62	{1438}.....32, 55	{1523}.....71
{1343}.....62	{1439}.....64	{1524}.....71
{1344}.....62	{1440}.....64	{1525}.....71
{1345}.....63	{1441}.....65	{1526}.....71
{1346}.....63	{1442}.....64	{1527}.....58
{1347}.....63	{1443}.....64	{1529}.....63
{1348}.....63	{1444}.....65	{1530}.....63
{1350}.....63	{1446}.....64	{1531}.....45
{1351}.....63	{1447}.....64	{1532}.....45
{1352}.....63	{1448}.....64	{1533}.....67
{1353}.....63	{1451}.....47	{1536}.....32, 53, 54
{1354}.....63, 64	{1452}.....48	{1537}.....65
{1355}.....63	{1453}.....50	{1538}.....65
{1356}.....63	{1454}.....51	{1539}.....65
{1357}.....63	{1455}.....61	{1540}.....65
{1358}.....63	{1456}.....61	{1541}.....65
{1359}.....63	{1457}.....64	{1542}.....65



INDEX OF THE NUMBERS OF PARAMETERS (XXXX)

{1543}	62	{1588}	65	{5019}	22
{1544}	62	{1589}	65	{5026}	25
{1545}	65	{1590}	65	{5027}	25
{1546}	54	{1591}	65	{5030}	24
{1547}	70	{1592}	65	{5031}	25
{1548}	52	{1593}	65	{5032}	23
{1549}	32, 53, 54	{1594}	65	{5033}	24
{1550}	69	{1595}	65	{5034}	24
{1560}	52	{1596}	65	{5036}	21
{1565}	67	{1597}	65	{5038}	21
{1566}	57	{1598}	65	{5039}	21
{1567}	57	{1599}	55	{5040}	21
{1568}	44	{5000}	21	{5041}	23
{1569}	59, 66	{5001}	22	{5042}	22
{1570}	59, 66	{5002}	22	{5043}	22
{1571}	70	{5006}	25	{5044}	22
{1576}	66	{5007}	25	{5045}	25
{1578}	66	{5008}	25	{5049}	24
{1579}	66	{5009}	25	{5050}	24
{1580}	55	{5010}	25	{5056}	26
{1581}	65	{5011}	25	{5057}	23
{1582}	65	{5012}	22	{5058}	23
{1583}	65	{5013}	23	{5059}	23
{1584}	65	{5015}	24	{5068}	23
{1585}	65	{5016}	24	{5069}	24
{1586}	65	{5017}	24	{5073}	26
{1587}	65	{5018}	24	1309	58

NOTES



Kelvinlaan 82, 9207 JB Drachten, Netherlands
Tel : + 31-512-571550 / Fax : + 31-512-571599
www.whisperpower.eu / info@whisperpower.nl